



GJ Enterprises



Kitchen

Mechanisms and accessories

ABOUT US

GJ Enterprises was established in 2001 in a venture to facilitate as a one-stop-shop for the complete range of hardware for Kitchens, Wardrobes, Glass partitions, Locking solutions and other exclusive Interior Decorative accessories. The core idea was to persuade customers to add their own edge to their living and working spaces by using creative hardware accessories that we selectively import from some of the leading hardware manufacturers in Europe. In 2016, we launched our Experience Centre in OMR, Thoraipakkam, displaying our entire range of products. This step was taken with the intention and foresight of giving our customers a physical feel of the pristine quality of the products that we offer.

01 Larder
Unit

09 Pocket
Door

12 Midway
and Overheads

23 Tandem Pullouts



CONTENTS

33 Basepullouts

45 Undersink storage
solutions

51 Cutlery
Organiser

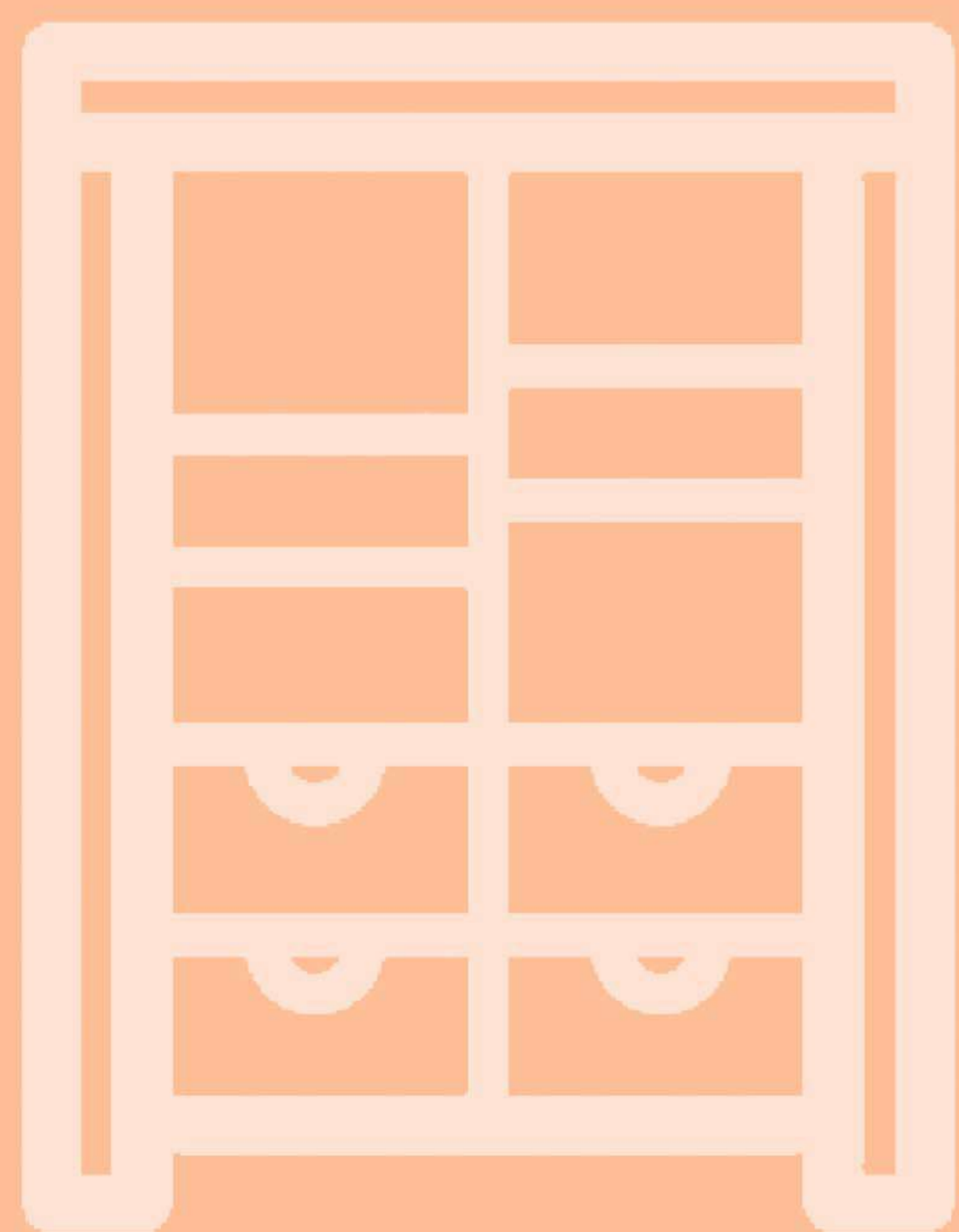

01 Larder
Unit



00

02

LARDER UNIT

TANDEM PANTRY

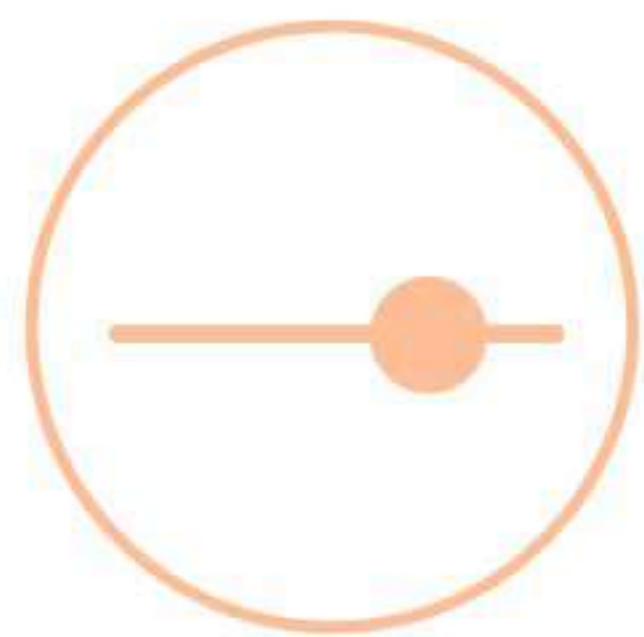

Price range



48 Kgs max



Pantry

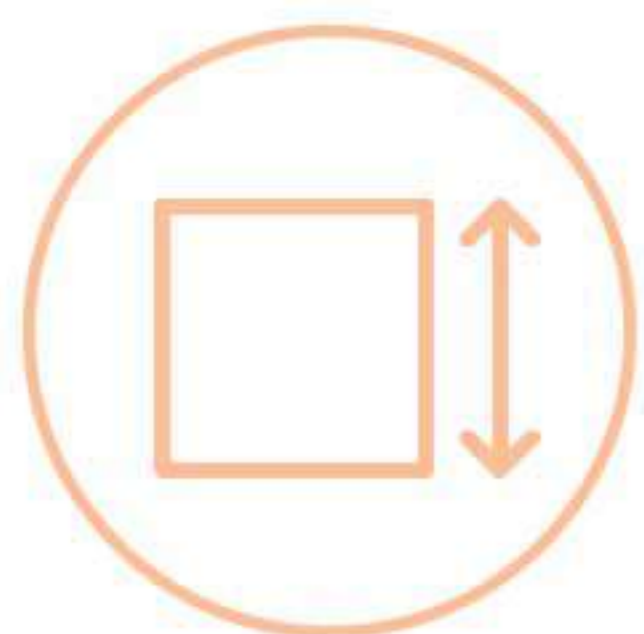

Cabinet Height
450mm, 600mm



Cabinet Width
1940-2150mm

LEGERGERAT GLASS PANTRY

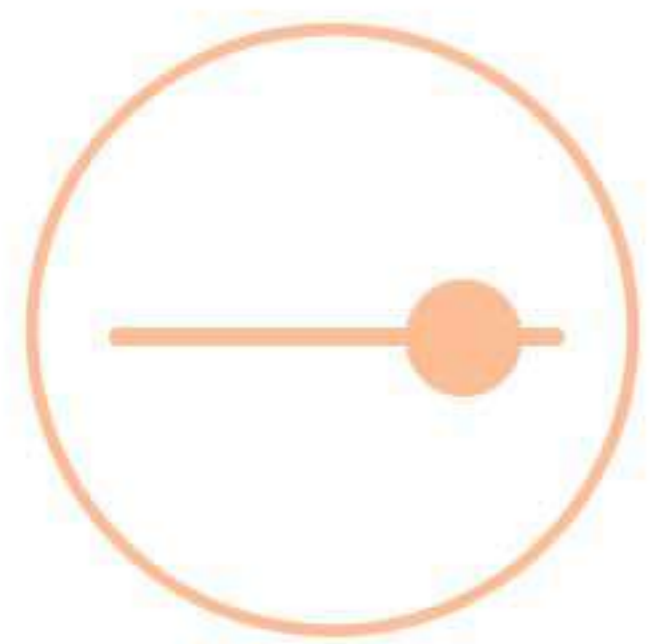

Price range



55 Kgs max

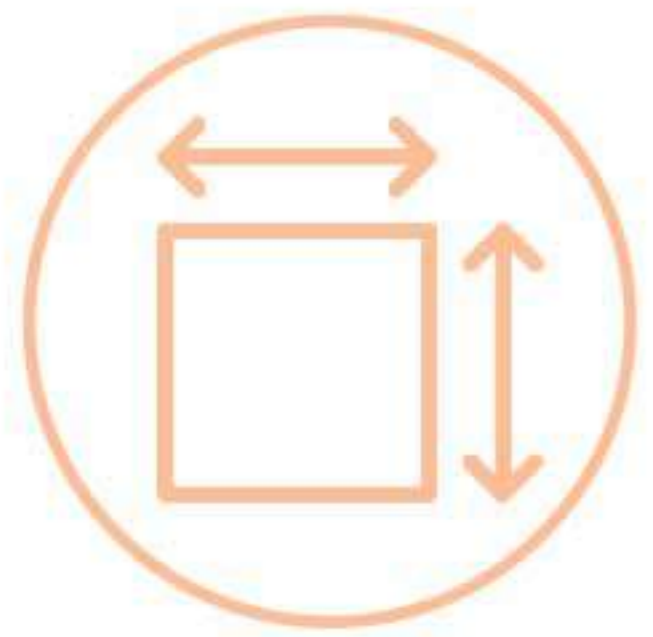

W X D X H
450 X 480 X 1800-2300
600 X 480 X 1800 -2300



Pantry

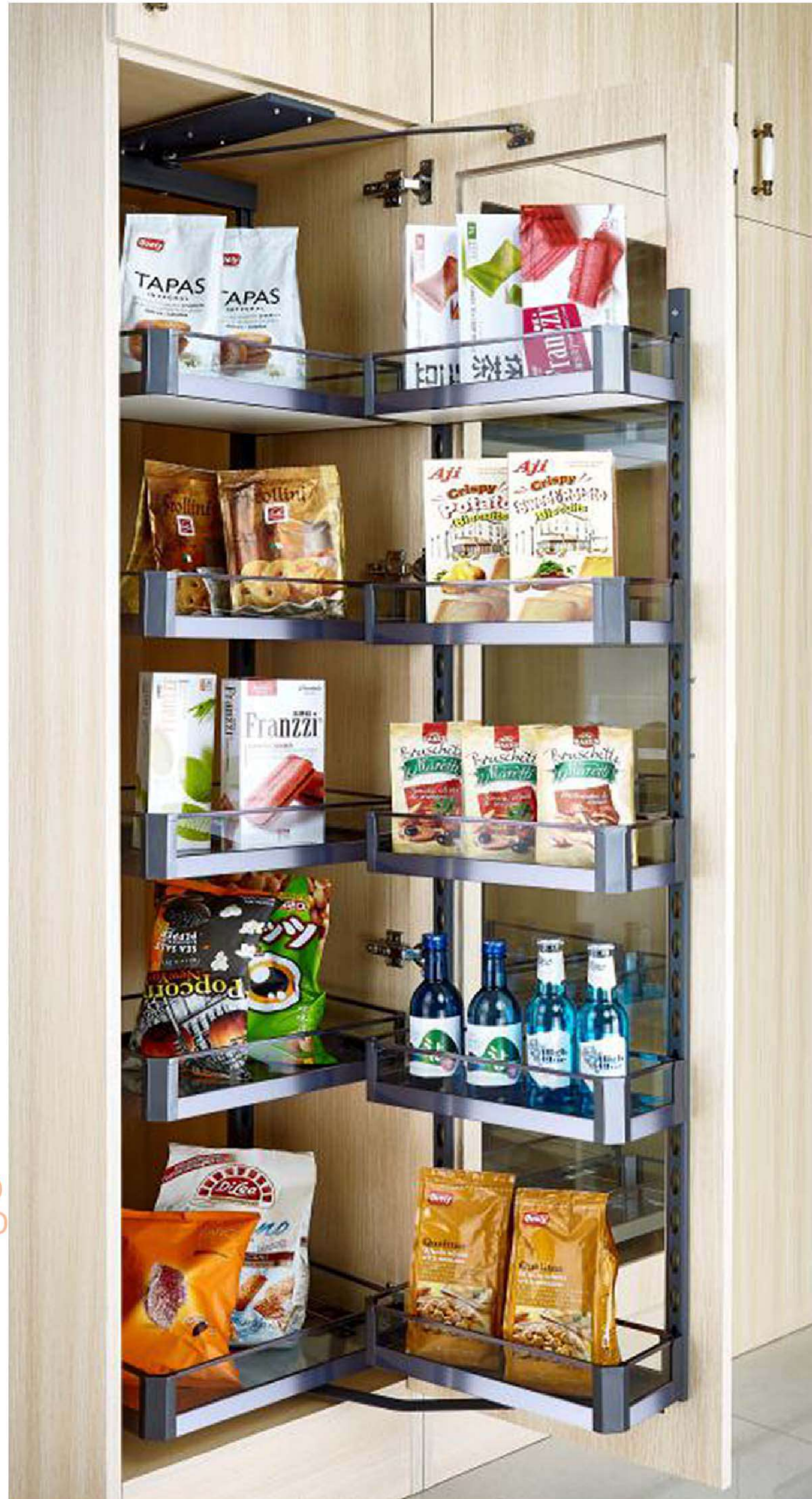

PREMIUM PANTRY



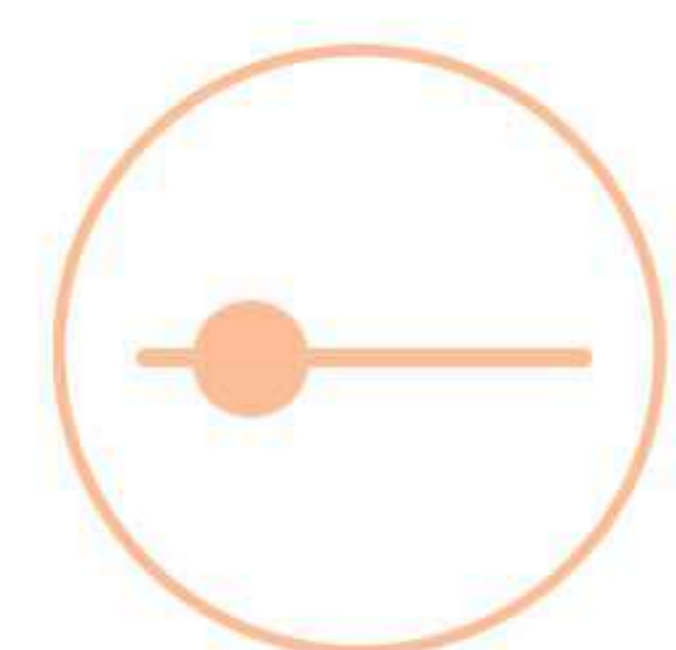

Price range



40 Kgs max

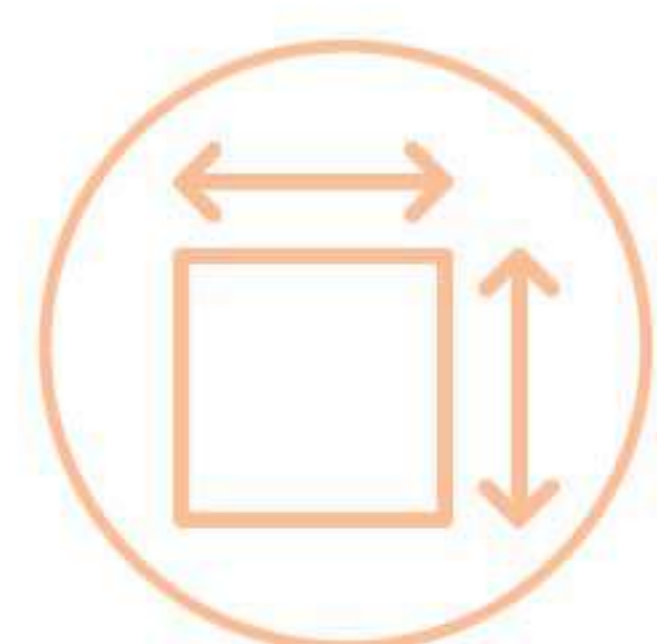

W X D X H

450 X 480 X 1800-2300
600 X 480 X 1800 -2300



Pantry



LARDER PULLOUT

DISPENSA VVS

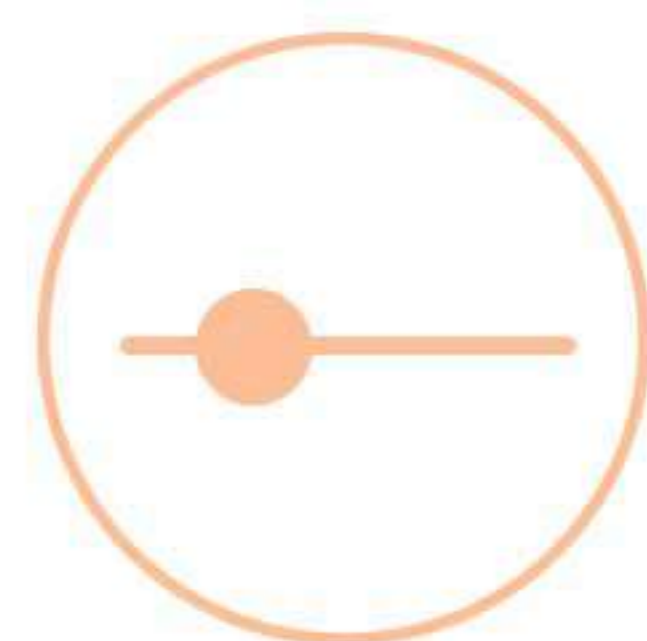

Price range



40 Kgs max

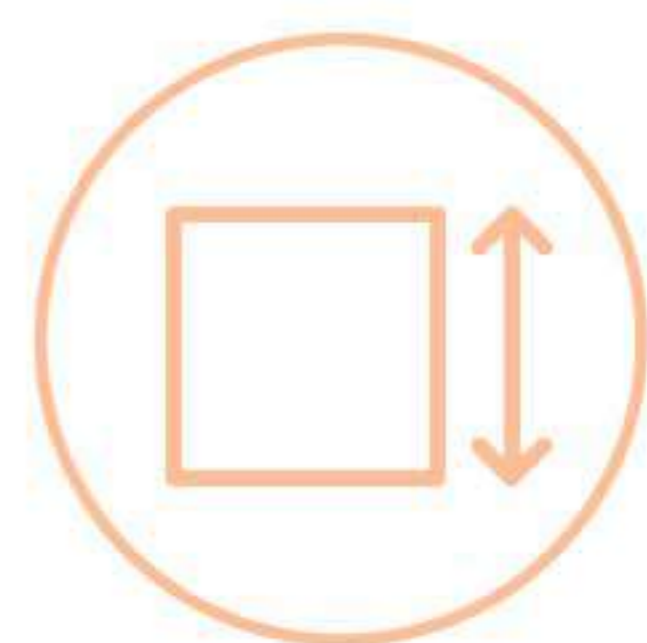

Height
1900-2300mm

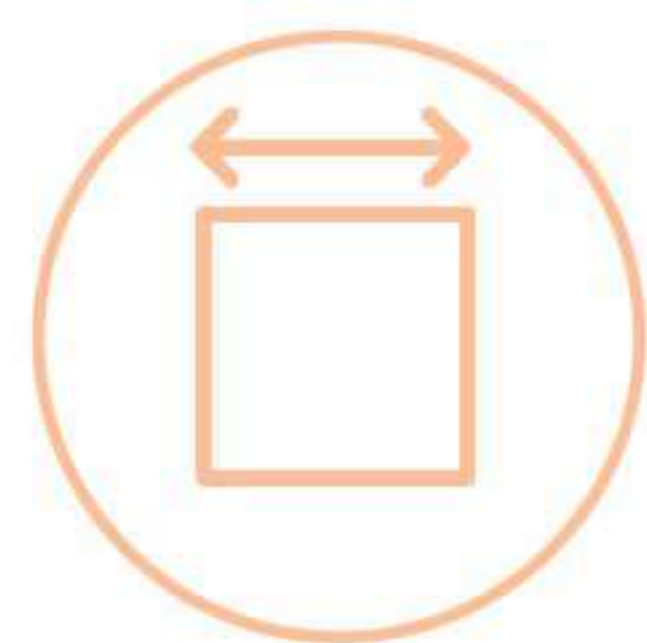

Width
150,300,400mm



CONVOY LAVIDO

- Larder unit full-extension pull-out incl. door follower.
- Only one gentle pull to move all the contents out in front.
- Instant access to all contents from 3 sides.

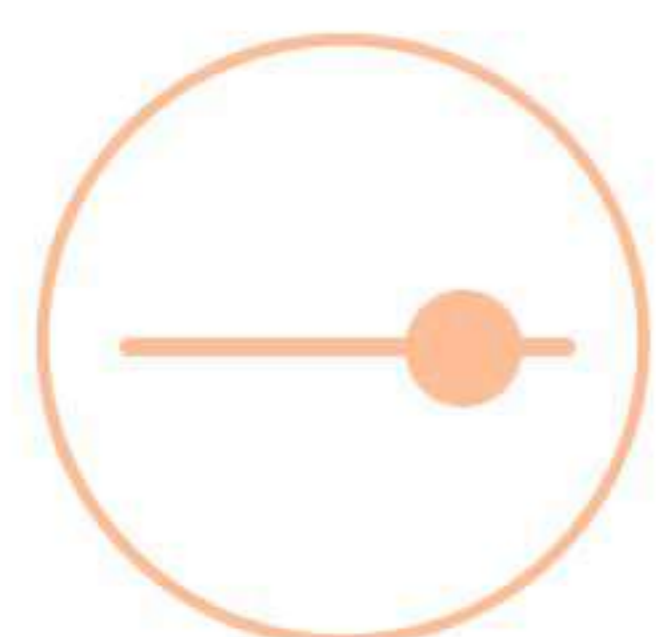

Price range



20 Kgs per tray



Cabinet width
450mm & 600mm

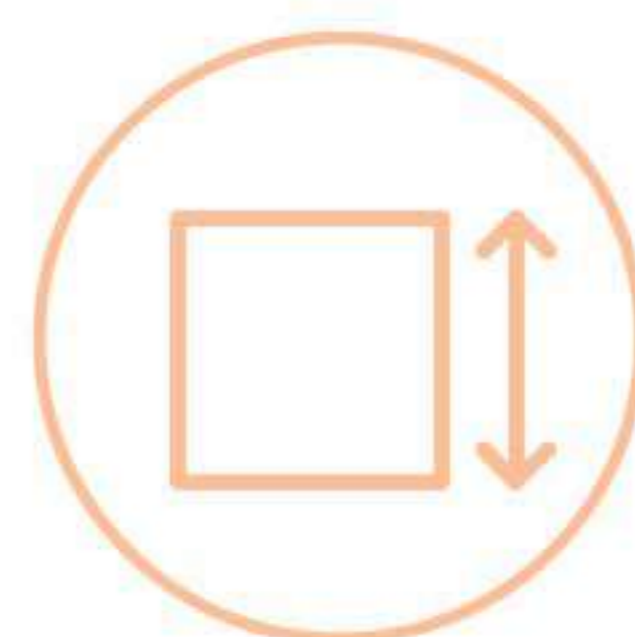

Height
1900-2300mm



INNER DRAWER PULLOUT

CRYSTAL
RAILING



ROUND
RAILING



RECTANGULAR
RAILING

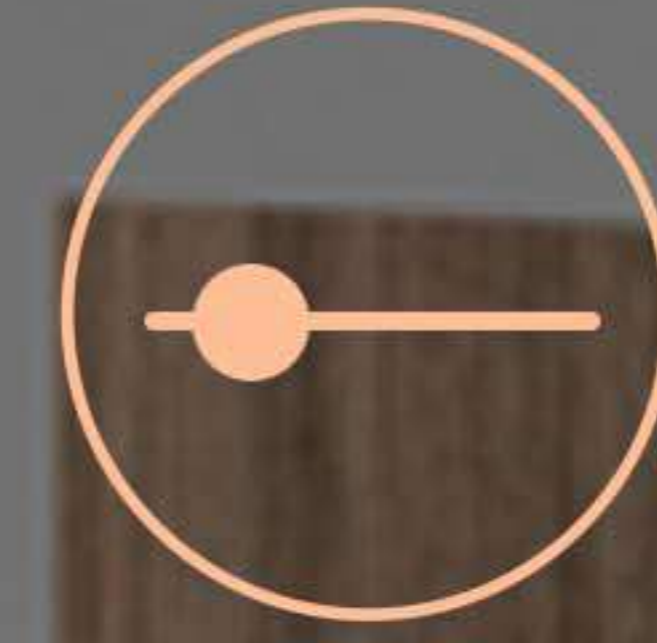

Price range



40 Kgs max

INNER DRAWER PULLOUT - MIO TALL



- Individually compiled organisation pullout for optimum dishes storage.
- Freely combined with Mio interior & organization pullouts.
- High - end look with glass panorama front and sides as standard.

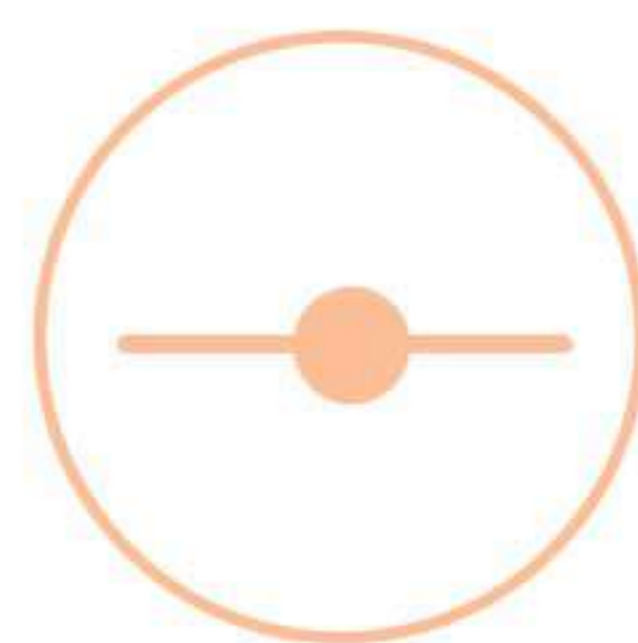

Price range



40 Kgs max



Cabinet width
450 mm
600 mm
900 mm

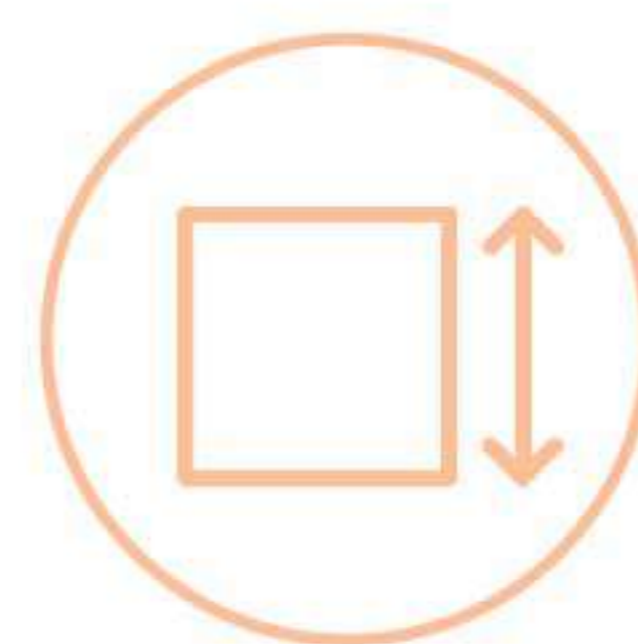

Cabinet height
98 mm
129 mm
167 mm



LEAMNS HIGHBOARD

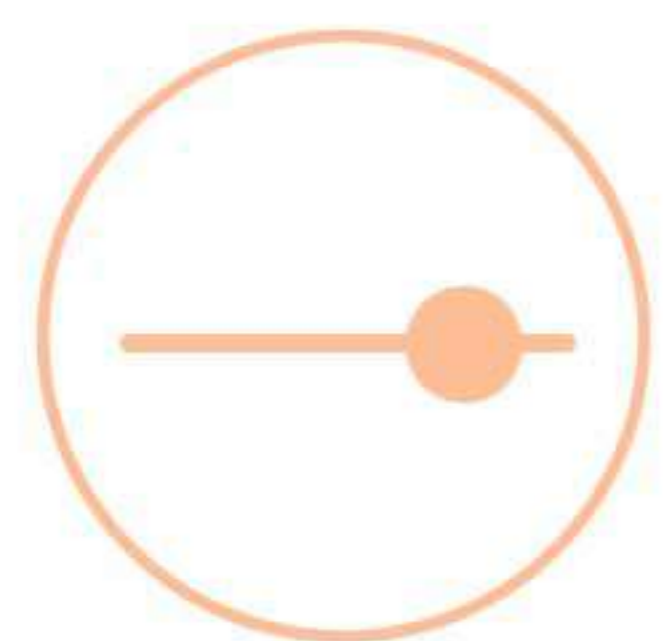

Price range



25 Kgs per tray

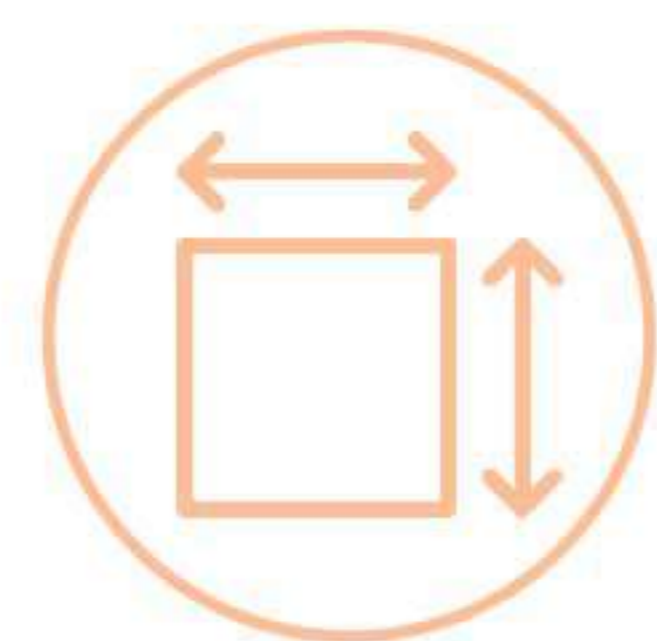

Shutter widths
450mm , 600mm
Inner clearance
900 - 1000mm
Axle Height
1250mm

01

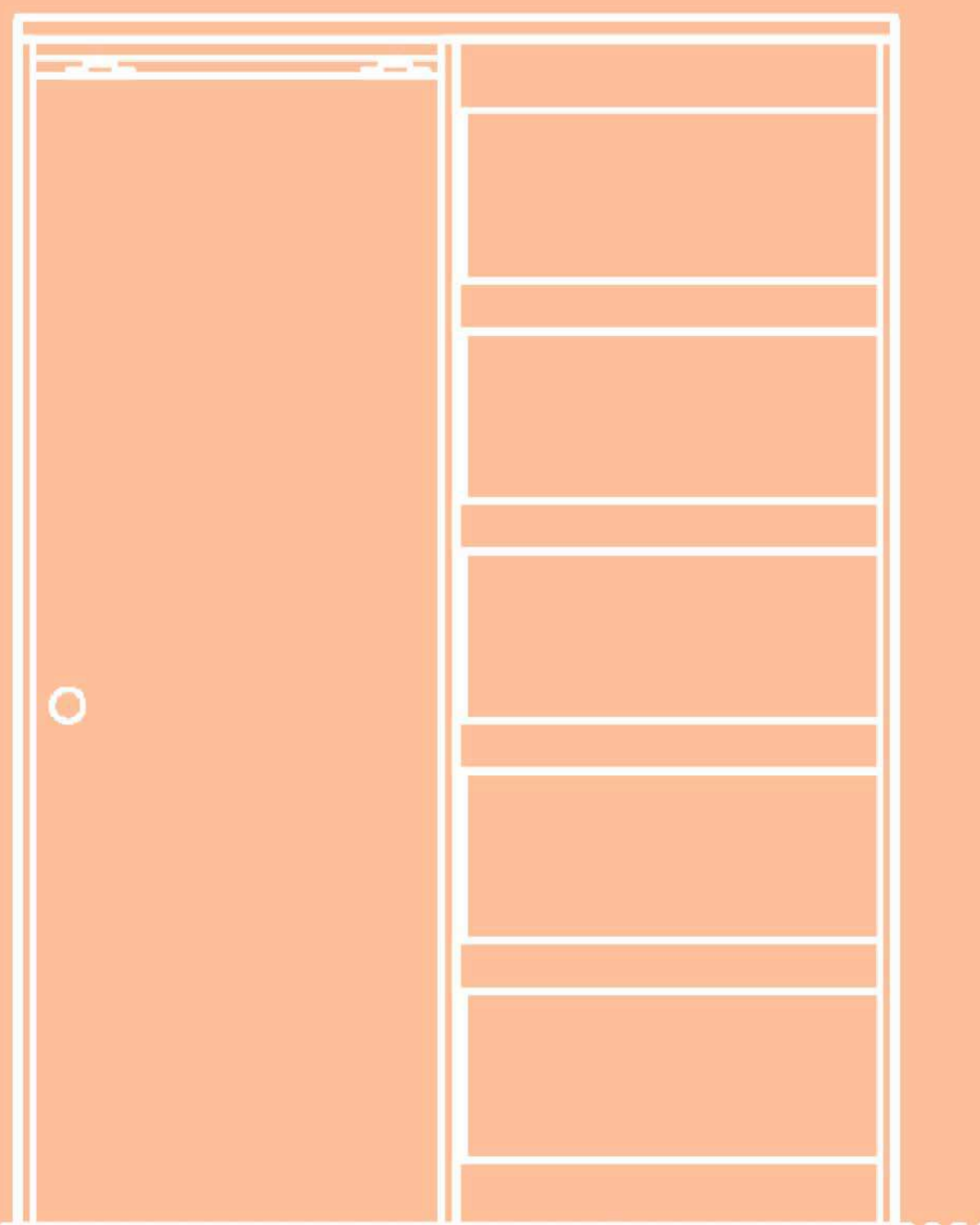

02 Pocket
Door >>>

03

POCKET DOOR FLAP IN SYSTEM



POCKET DOOR

FOR TALL DOORS

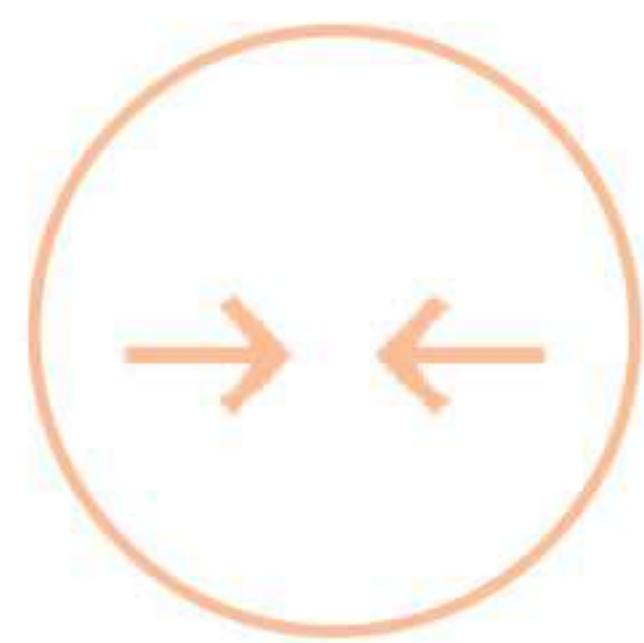

Depths
400, 450, 500,
550, 600 mm

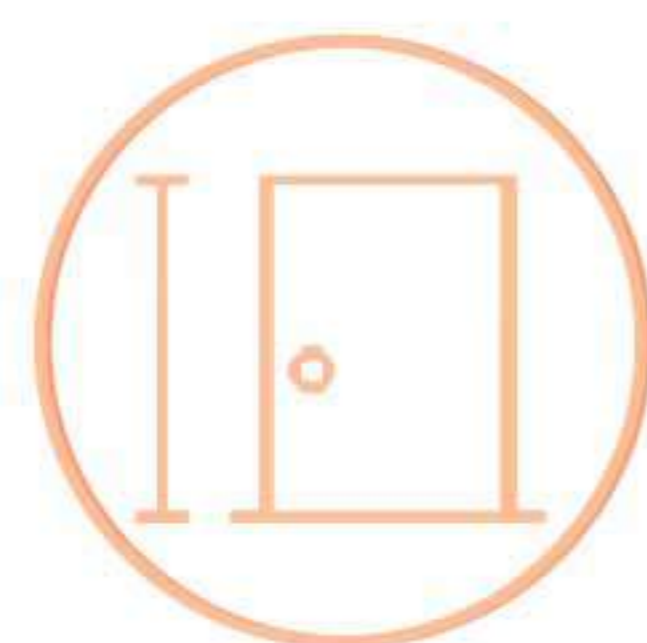

Height
2700 mm



Width
min 450 mm
max 600 mm

KITCHENETTE



PREPARATION STATION

02



03 Midway &
Overheads >>>

04

BLACK ROLLER SHUTTER

Windmix Swatches
FBS Italy



Stainless Steel

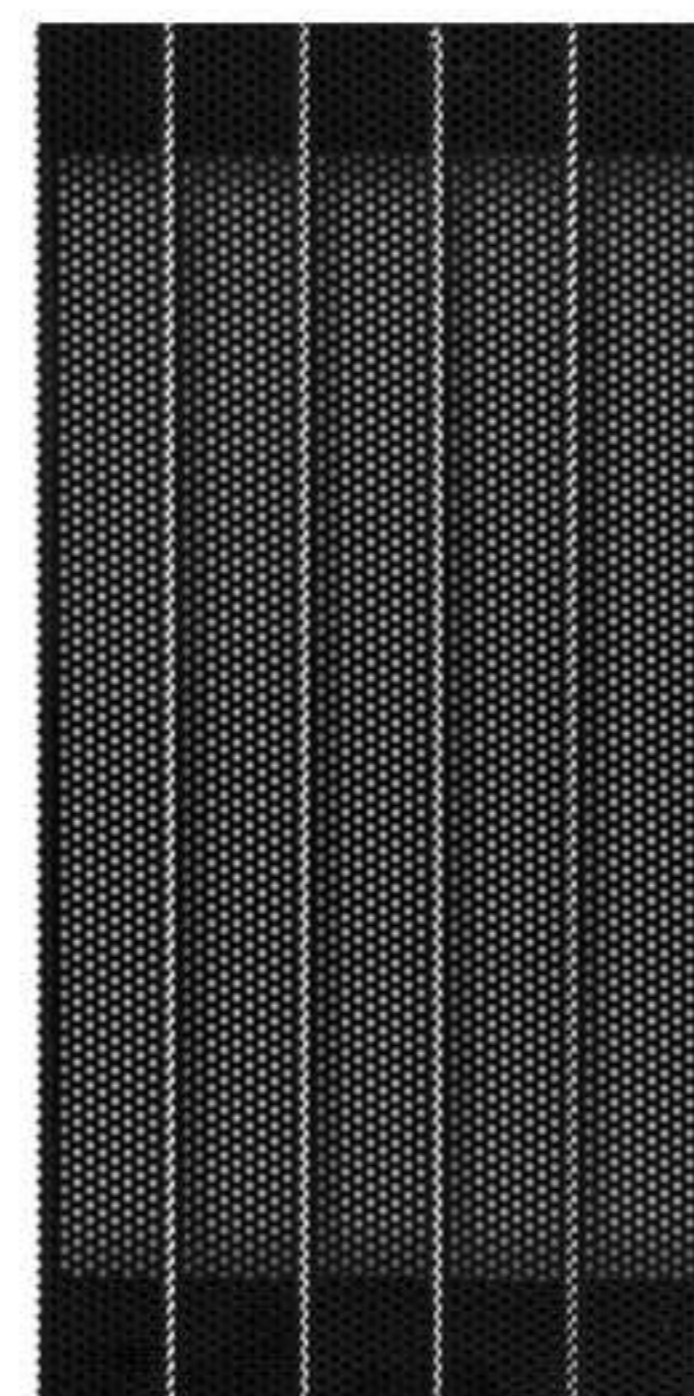

White Anodized

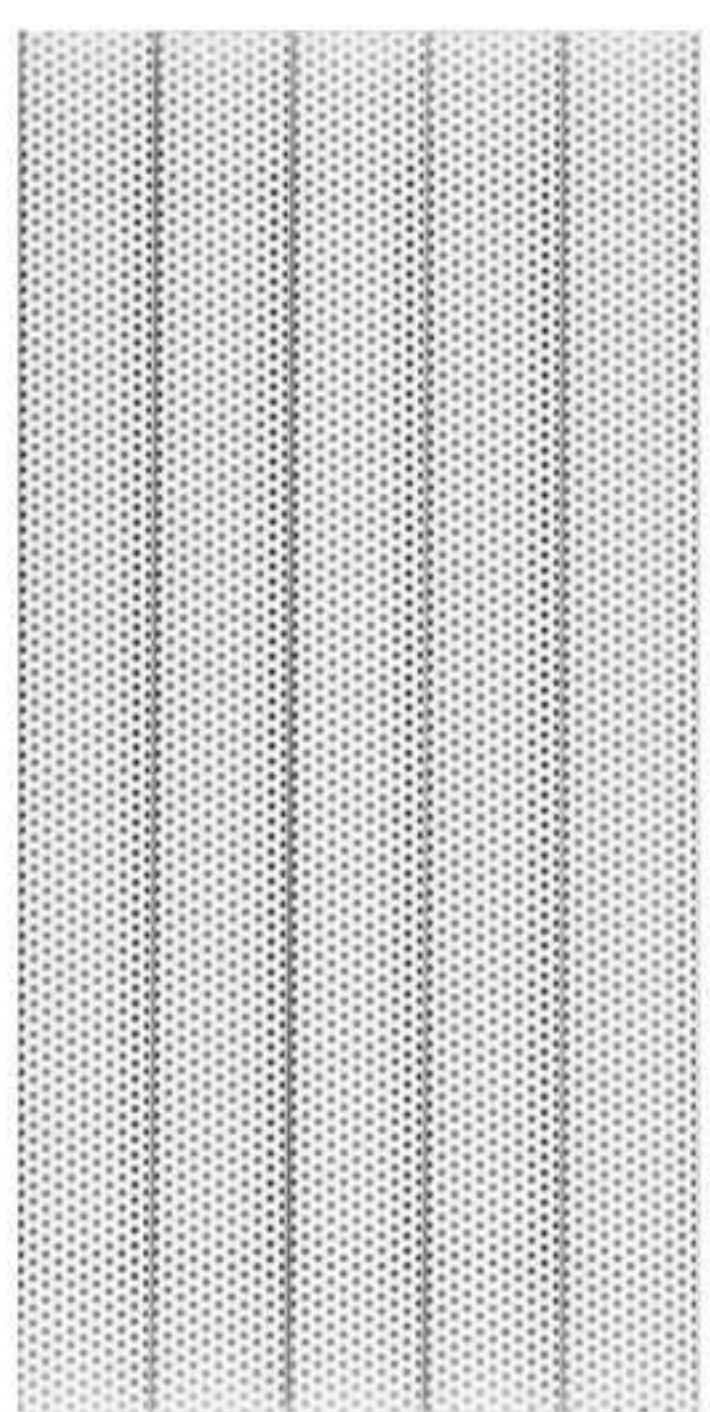

Black Anodized

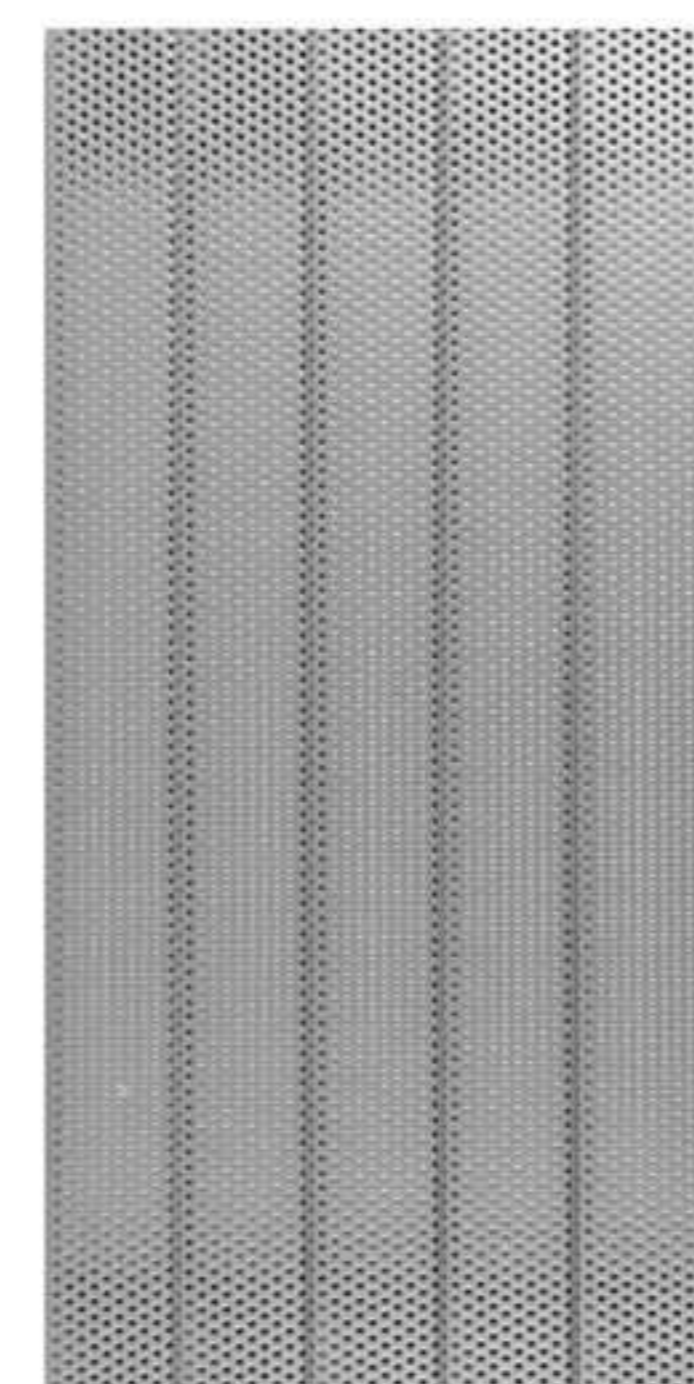

Alu Anodized

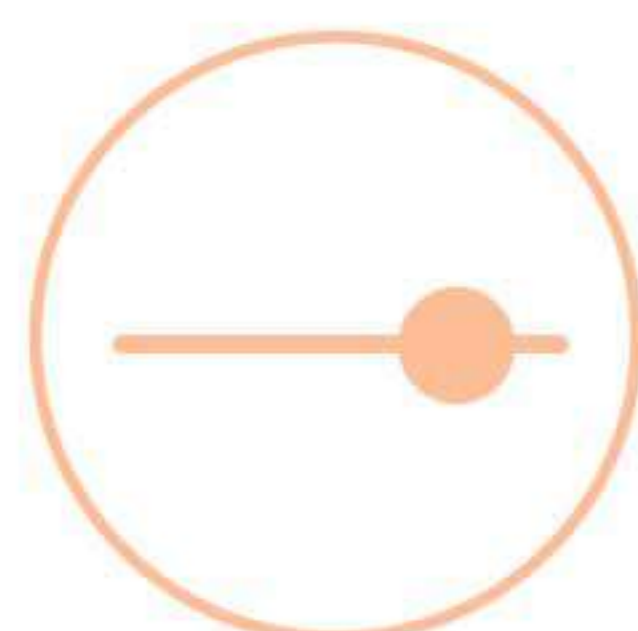

Price range

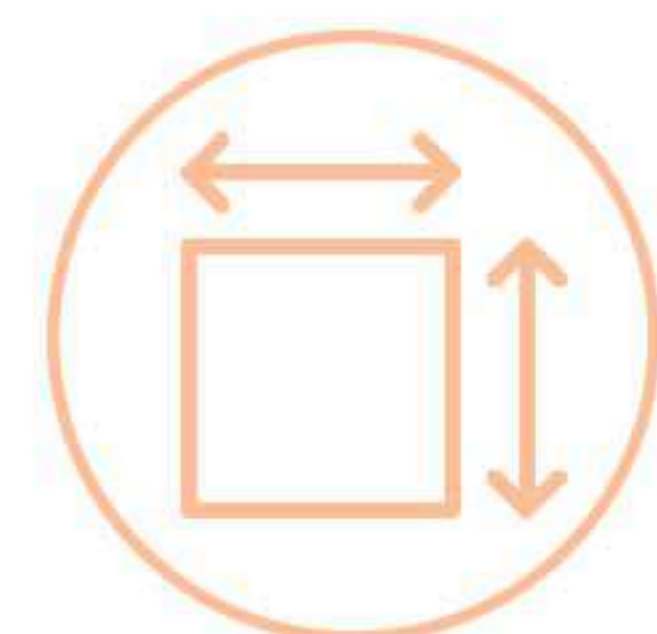

Cabinet dimensions
600 mm X 1400 mm
Accessory details
564 mm X 1364 mm



WHITE ROLLER SHUTTER

- Aesthetic, Elegant 40mm Slats

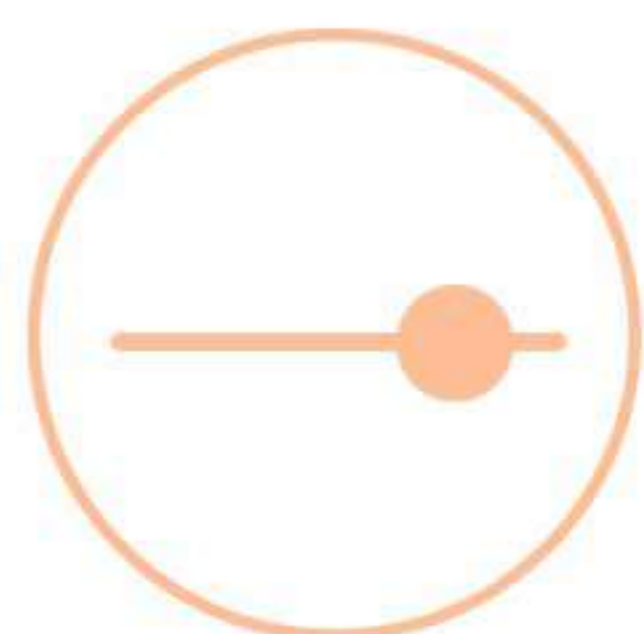

Price range

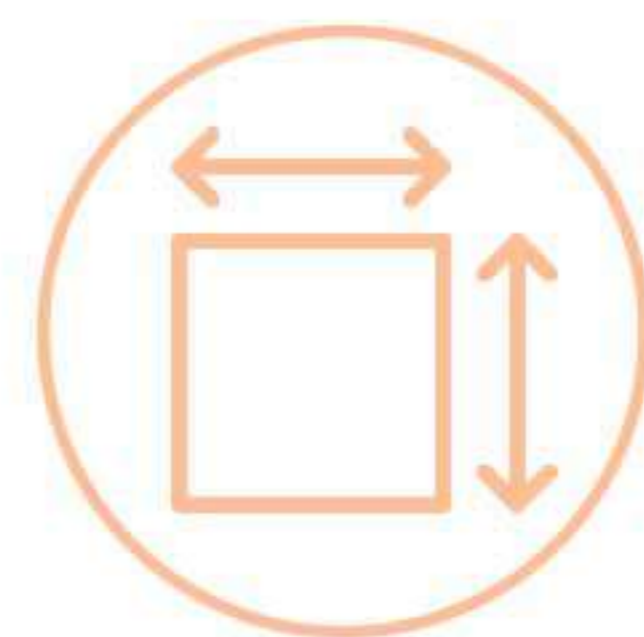

Cabinet dimensions
600 mm X 1400 mm
Accessory details
564 mm X 1364 mm



WHITE ROLLER SHUTTER

- Aesthetic, Elegant 40mm Slats

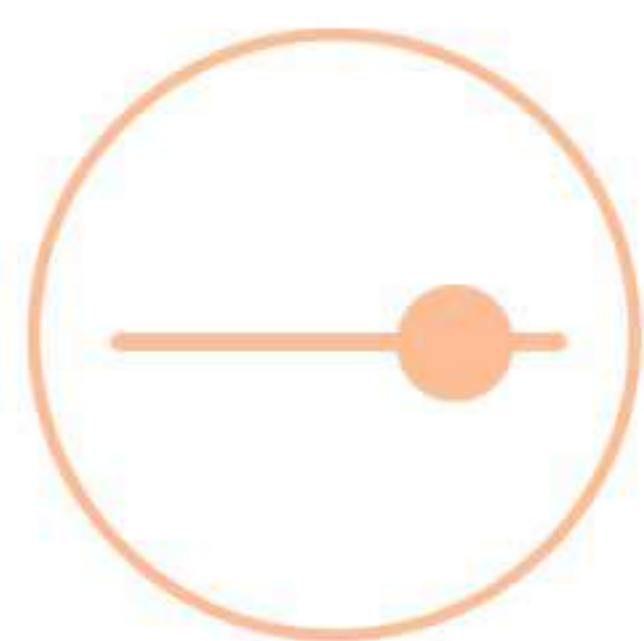

Price range

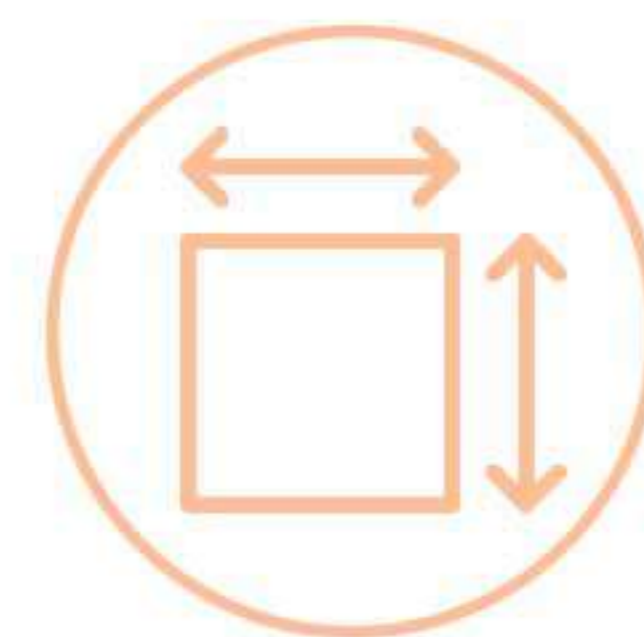

Cabinet dimensions
600 mm X 1400 mm
Accessory details
564 mm X 1364 mm



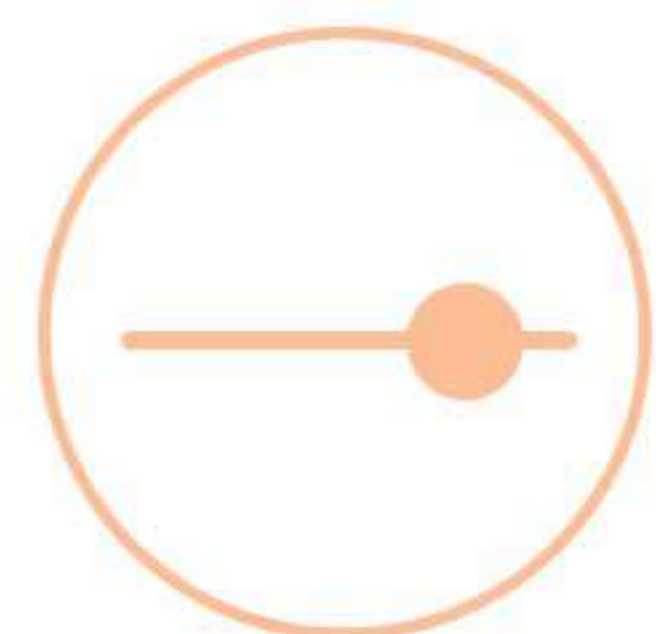

Price range

FREE FOLD

- Specially developed for tall wall units.
- Ideal for transparent glass fronts & units with interior lighting.
- Also for low ceilings and heavy fronts.



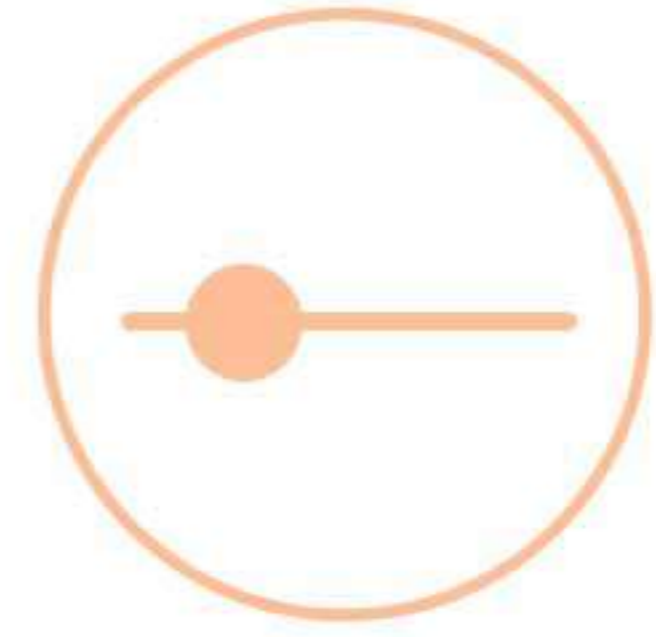

Price range

FREE SLIDE

- Precision lift for the front parallel to the cabinet
- For tall cabinets and for appliance cupboards, for example microwave cupboards
- Many specialist applications in kitchens, bathrooms and living areas



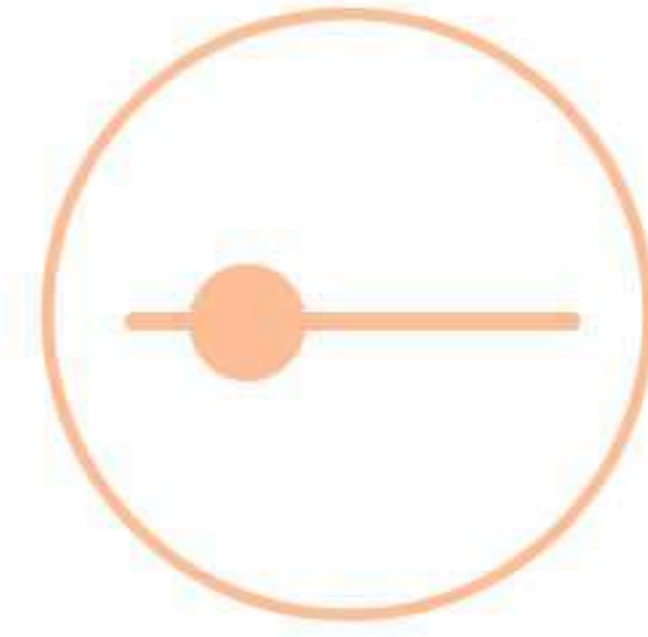

Price range



FREE FLAP

- Multi position stop
- Minimal installation depth (118 mm)
- Generates force to lift 27 kg.

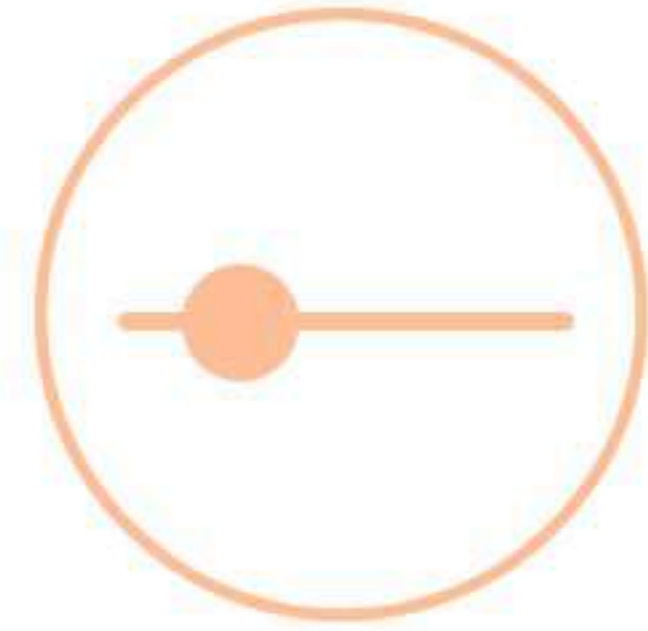

Price range

FREE SWING

- Precision lift for the front parallel to the cabinet.
- For tall cabinets and for appliance cupboards, for example microwave cupboards.
- Many specialist applications in kitchens, bathrooms and living areas.





IMOVE

- Easy lowering.
- No adjustment required.
- Tried and tested mechanisms.

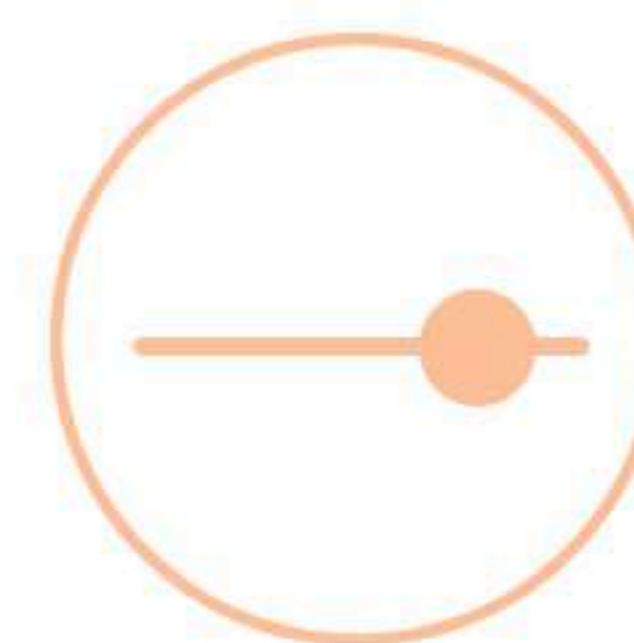

Price range



8 kgs

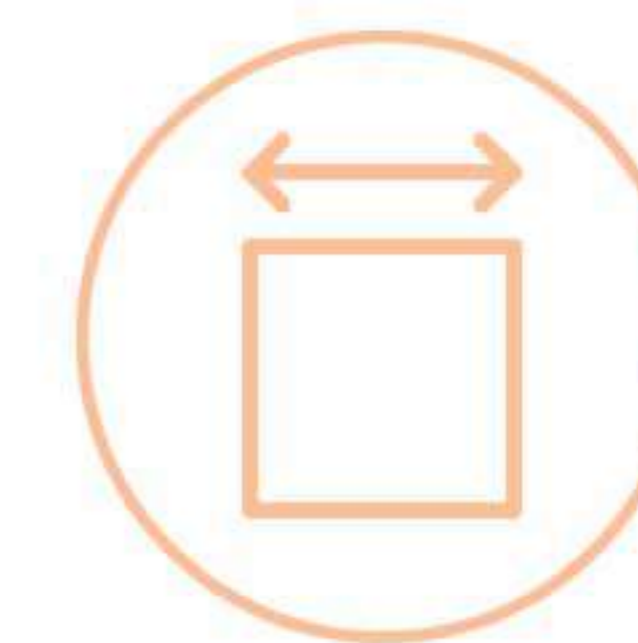

Cabinet width
600mm,900mm

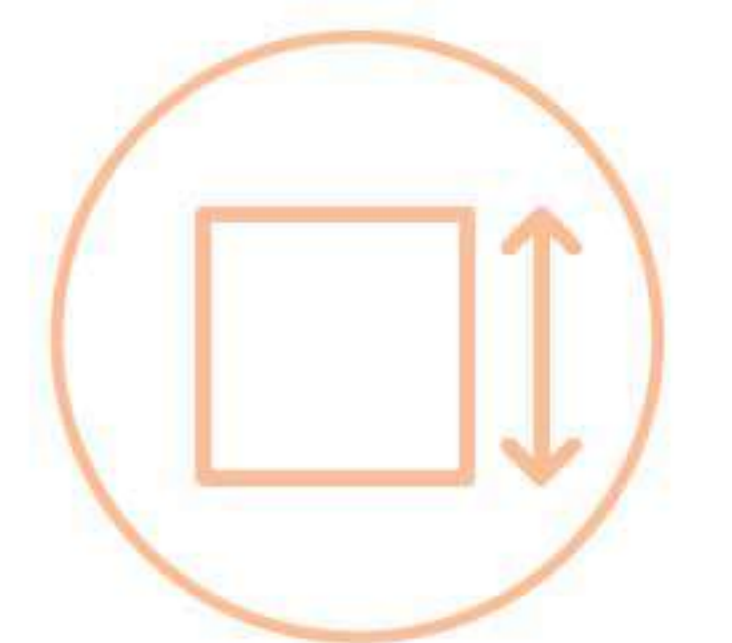

Cabinet depth
310 (Inner clearance)

ELEVATOR BASKETS

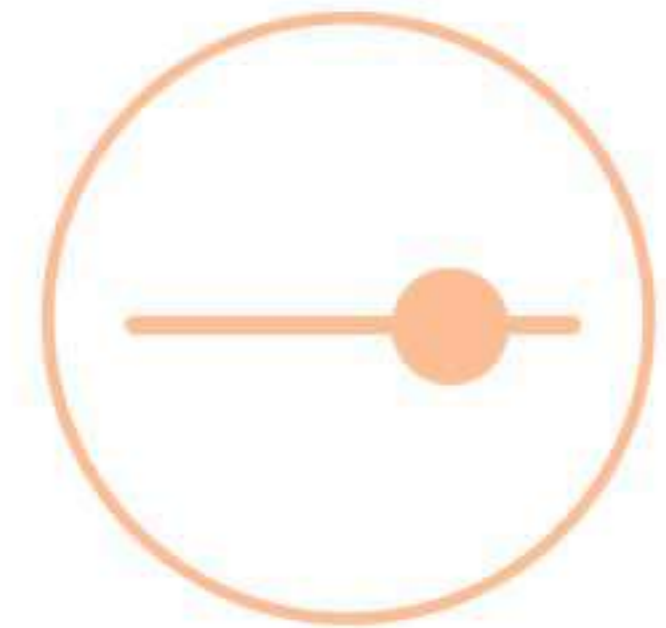
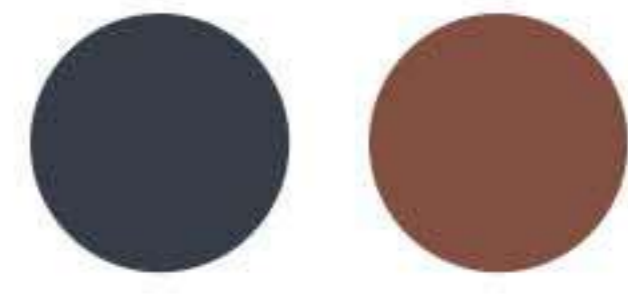

Price range



16-25 KGS



Width
600, 900 mm



Pantry



MIDWAY RALING SYSTEM



LADLE RACK



TALL SHELF



SHORT SHELF



SHELF WITH SPICE HOLDER

MIDWAY
RAIL SYSTEM



LADLE RACK



LADLE HOLDER



TISSUE HOLDER

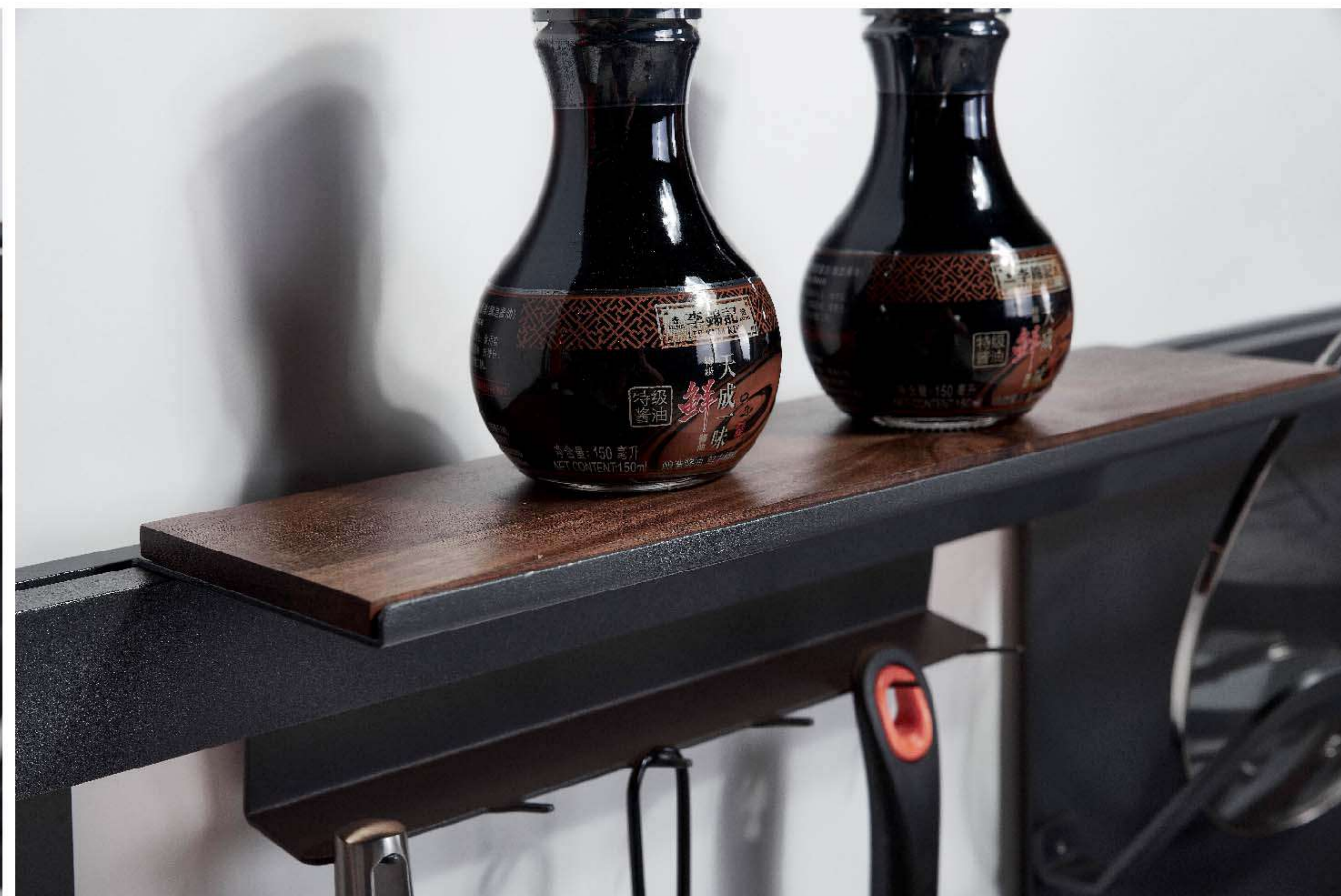

TOP HOLDER

03



04 Tandem
Pullouts >>>

05



H90

- Integrated height and side adjustment.
- The practical standard drawer for every application.
- Can be customised using designer panels.



Price range



40 kgs
& 70 kgs



H121

- Rectangular railing in harmonised design
- Flush-mounted back panel adapter
- Significantly fewer plastic parts

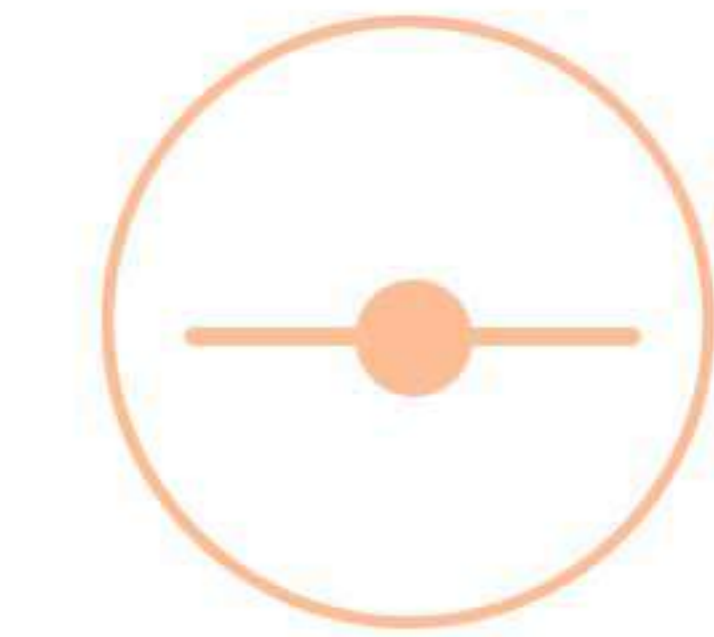

Price range



40 kgs
& 70 kgs



H185

- Integrated height and side adjustment.
- The practical standard drawer for every application.
- Can be customised using designer panels.

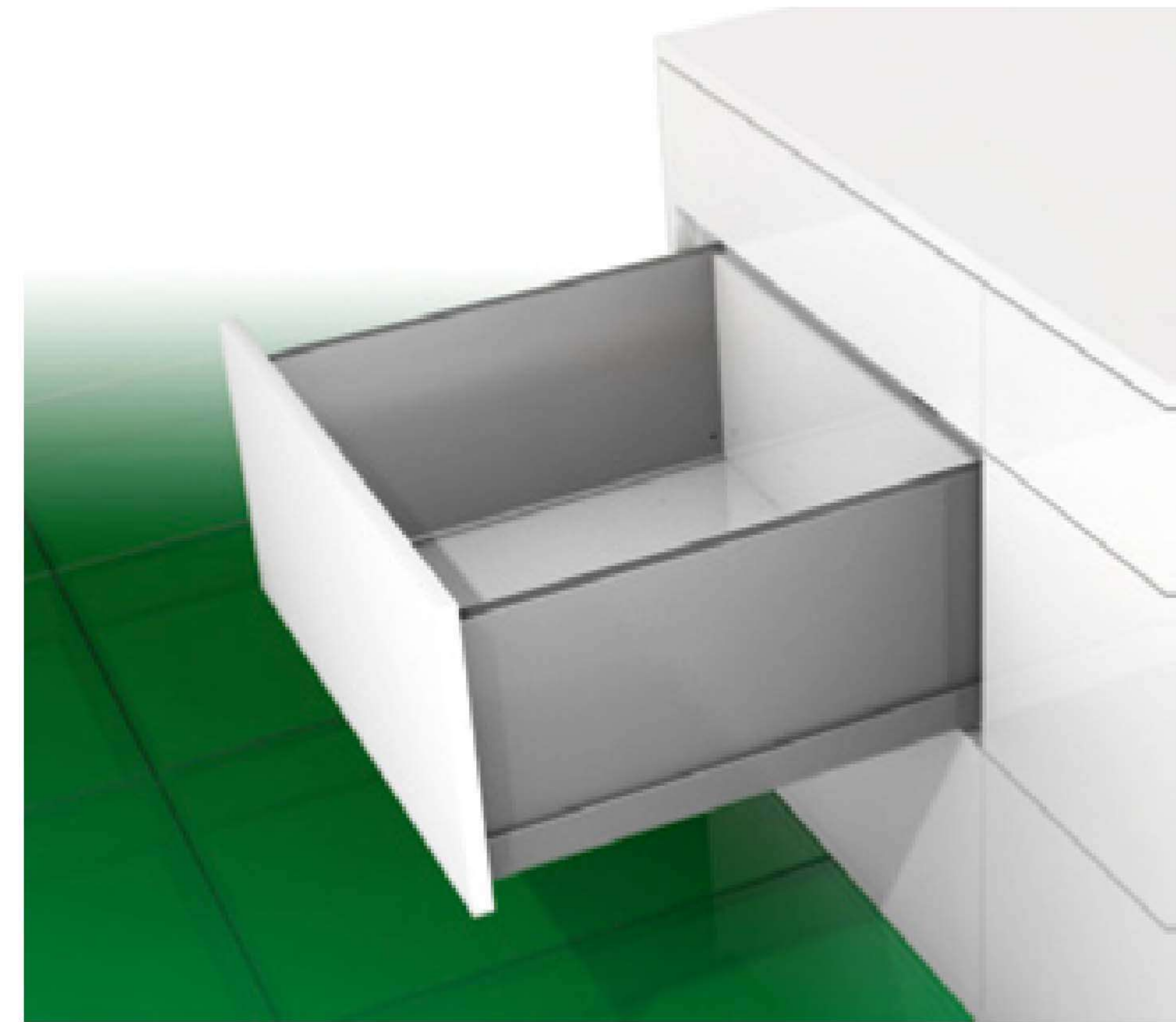

H249

- Rectangular railing in harmonised design.
- Flush-mounted back panel adapter.
- Significantly fewer plastic parts.

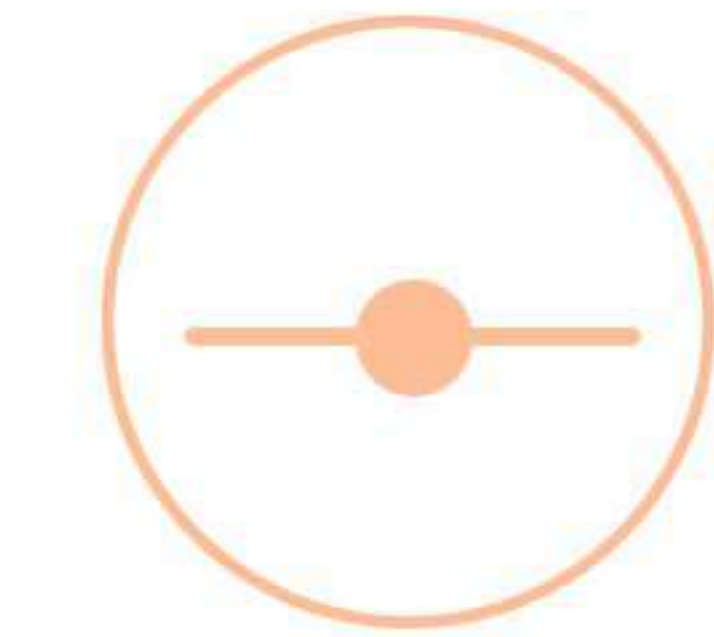

Price range



40 kgs
& 70 kgs

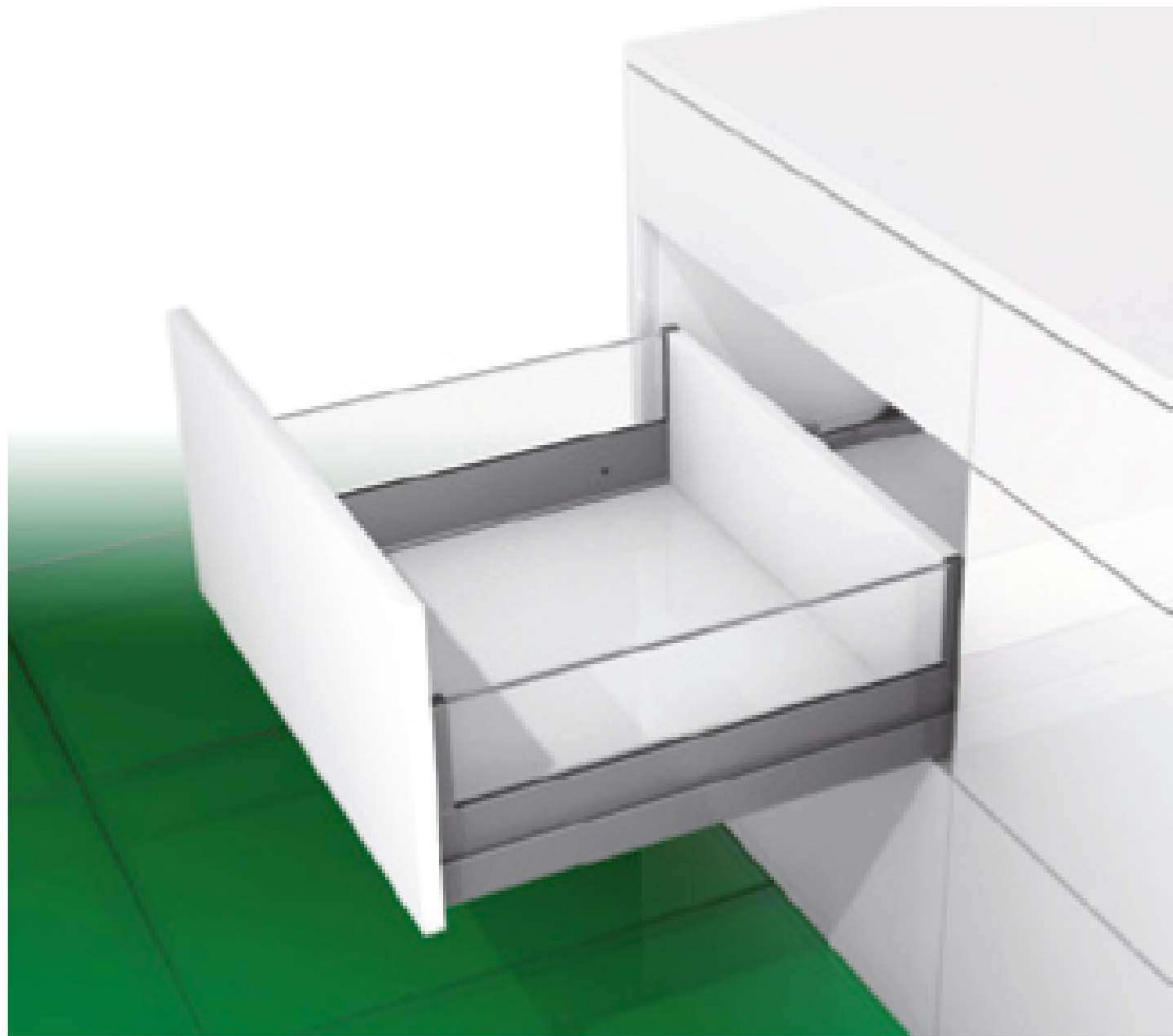

H90 Crystal line

- Integrated height and side adjustment.
- The practical standard drawer for every application.
- Can be customised using designer panels.



Rectangular railing drawer H90

- Rectangular railing in harmonised design.
- Flush-mounted back panel adapter.
- Significantly fewer plastic parts.

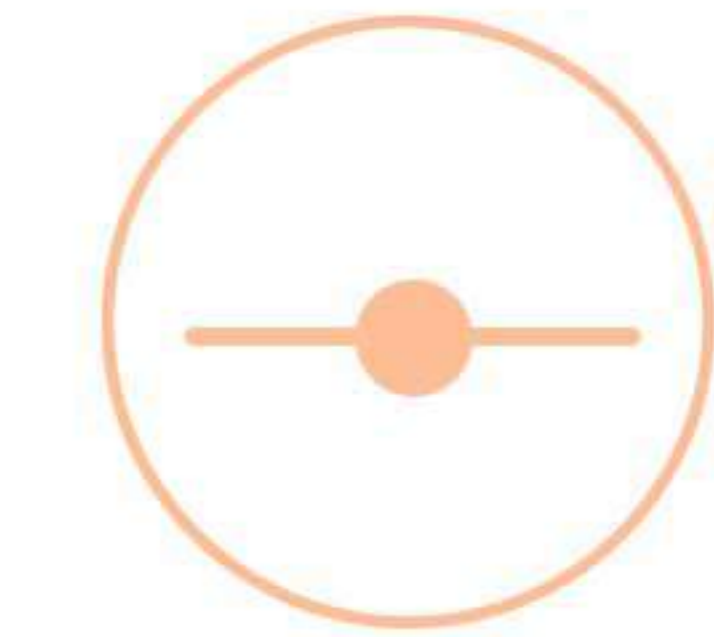

Price range



40 kgs
& 70 kgs



Nova Pro Scala - Crystal pro

- Integrated height and side adjustment.
- The practical standard drawer for every application.
- Can be customised using designer panels.

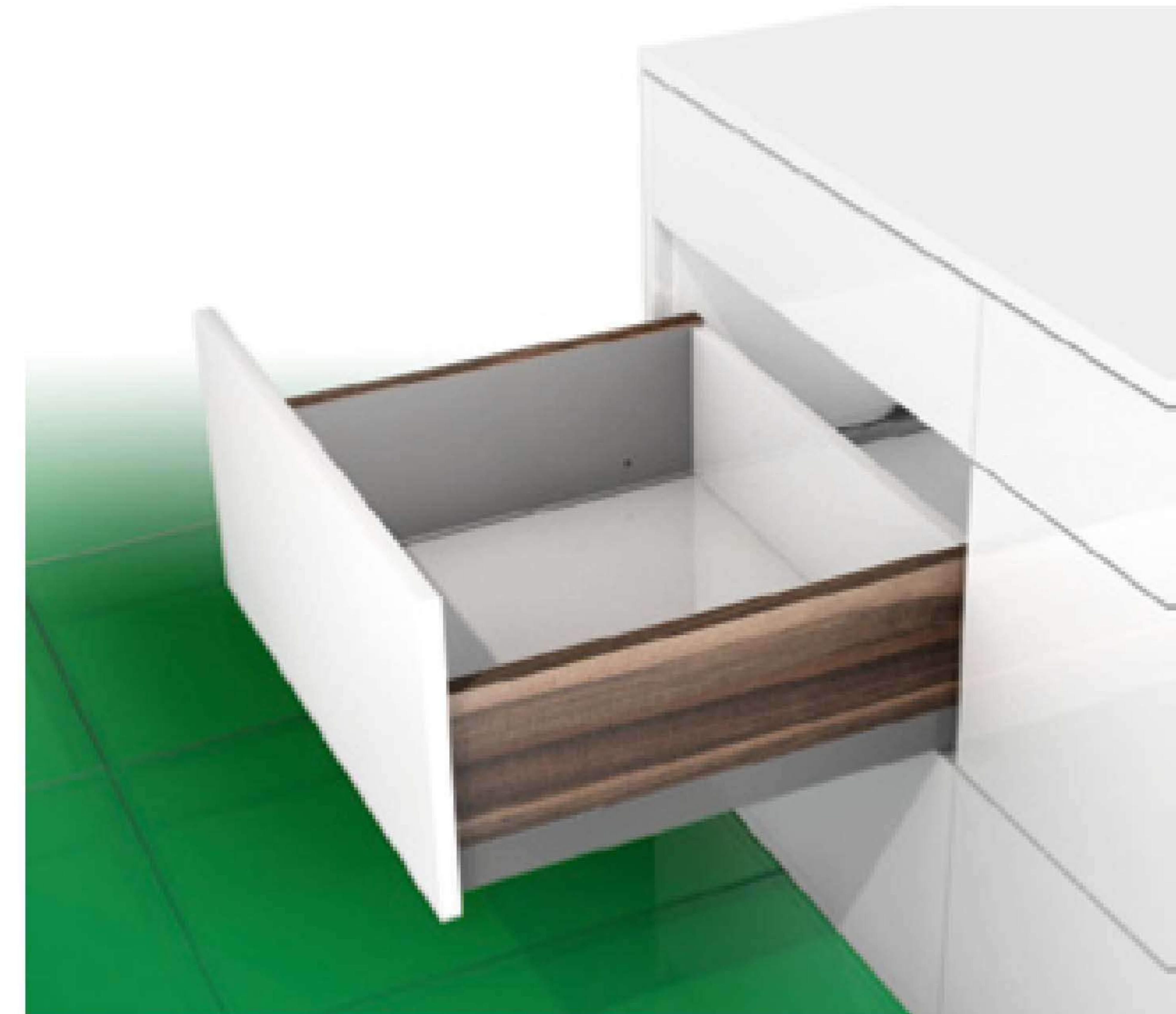

Nova Pro Scala - Variable Adaptor

- Rectangular railing in harmonised design.
- Flush-mounted back panel adapter.
- Significantly fewer plastic parts.

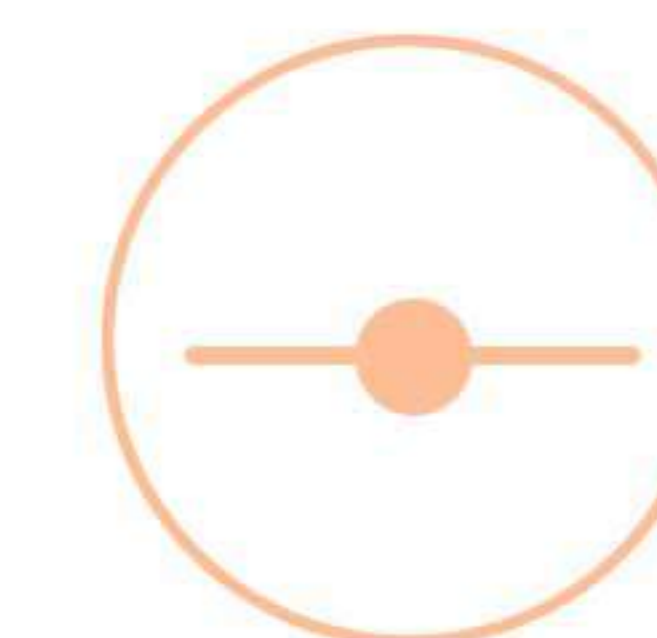

Price range



40 kgs
& 70 kgs



H 67mm

- Integrated height and side adjustment.
- The practical standard drawer for every application.
- Can be customised using designer panels.



H 89mm

- Rectangular railing in harmonised design.
- Flush-mounted back panel adapter.
- Significantly fewer plastic parts.



H 121mm

- Integrated height and side adjustment.
- The practical standard drawer for every application.
- Can be customised using designer panels.

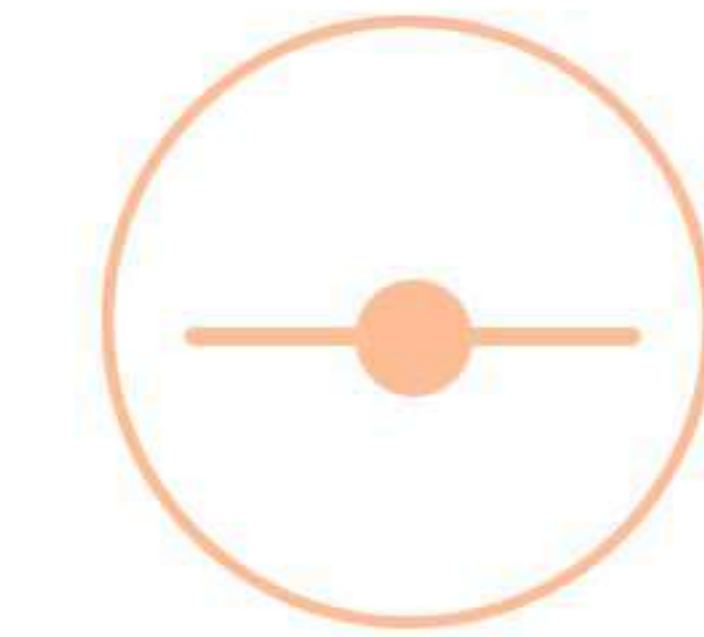

Price range



40 kgs
& 70 kgs



H 185mm

- Rectangular railing in harmonised design.
- Flush-mounted back panel adapter.
- Significantly fewer plastic parts.

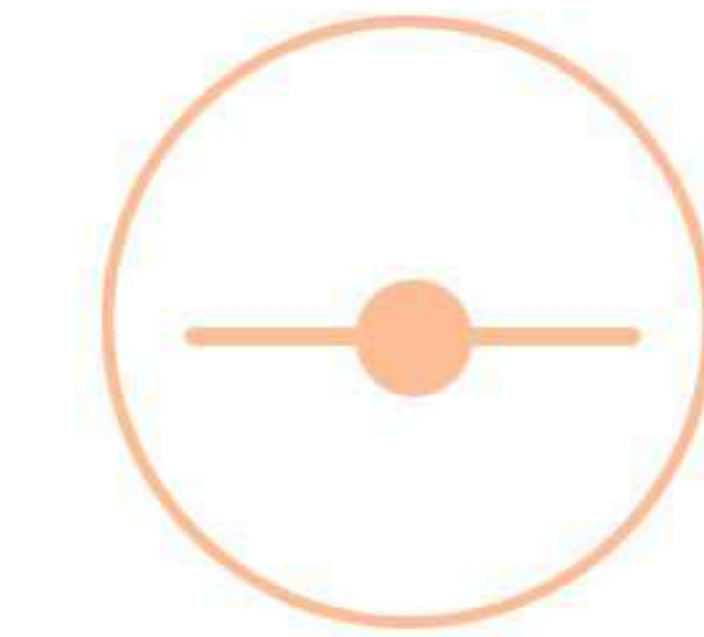

Price range



40 kgs
& 70 kgs



H90 mm Inner Drawer

- Integrated height and side adjustment.
- The practical standard drawer for every application.
- Can be customised using designer panels.



H185 mm Inner Drawer

- Rectangular railing in harmonised design.
- Flush-mounted back panel adapter.
- Significantly fewer plastic parts.

H142

- Affordable, Soft Closing Drawer Mechanism.
- Equipped with Synchronized Slides, made in Germany.
- Recommended for drawer widths upto 900mm.

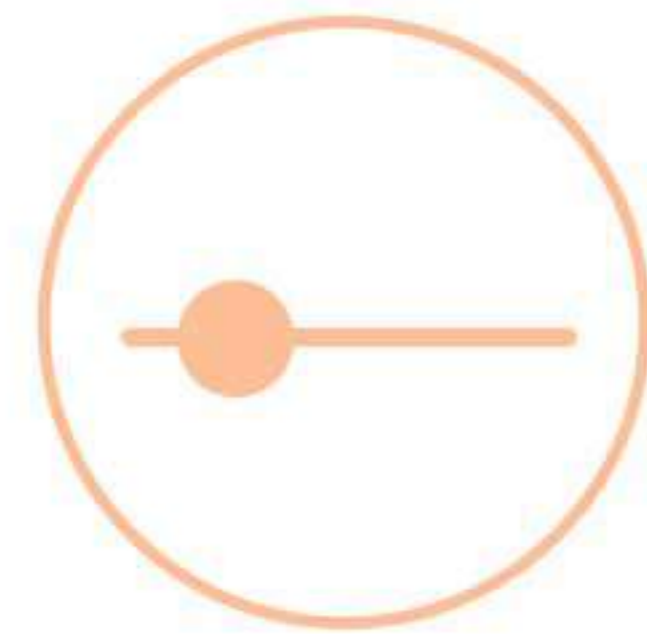

Price range



40 kgs max

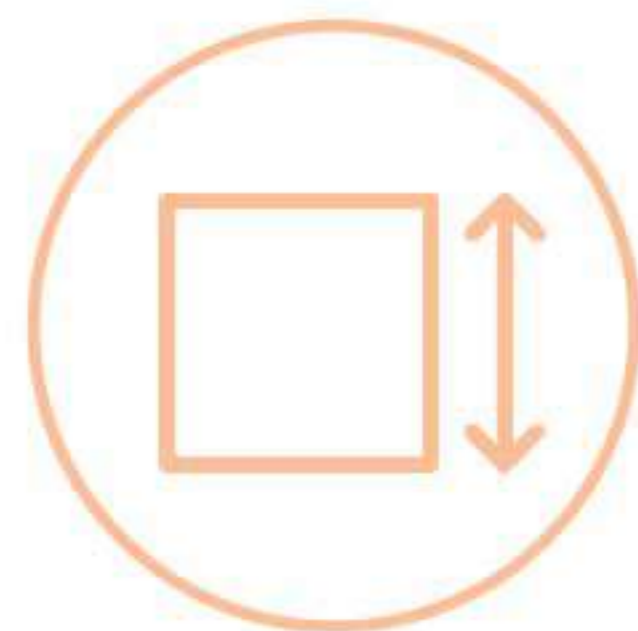

Drawer Height
68mm, 142mm
(with Gallery rail)

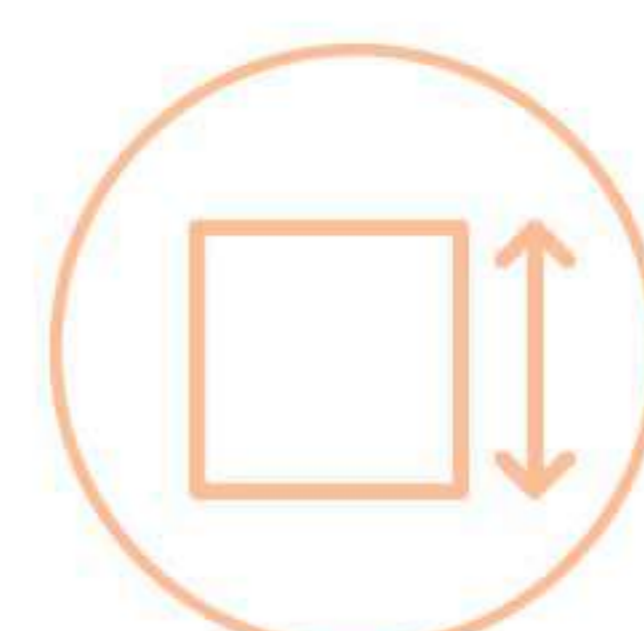

Drawer Height
185mm
(with Gallery rail)



MAGIC BOX

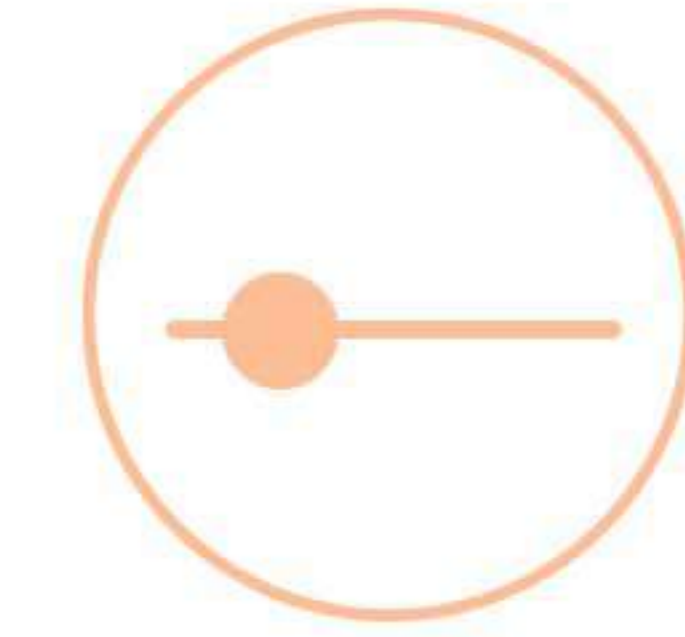

Price range



40 kgs max

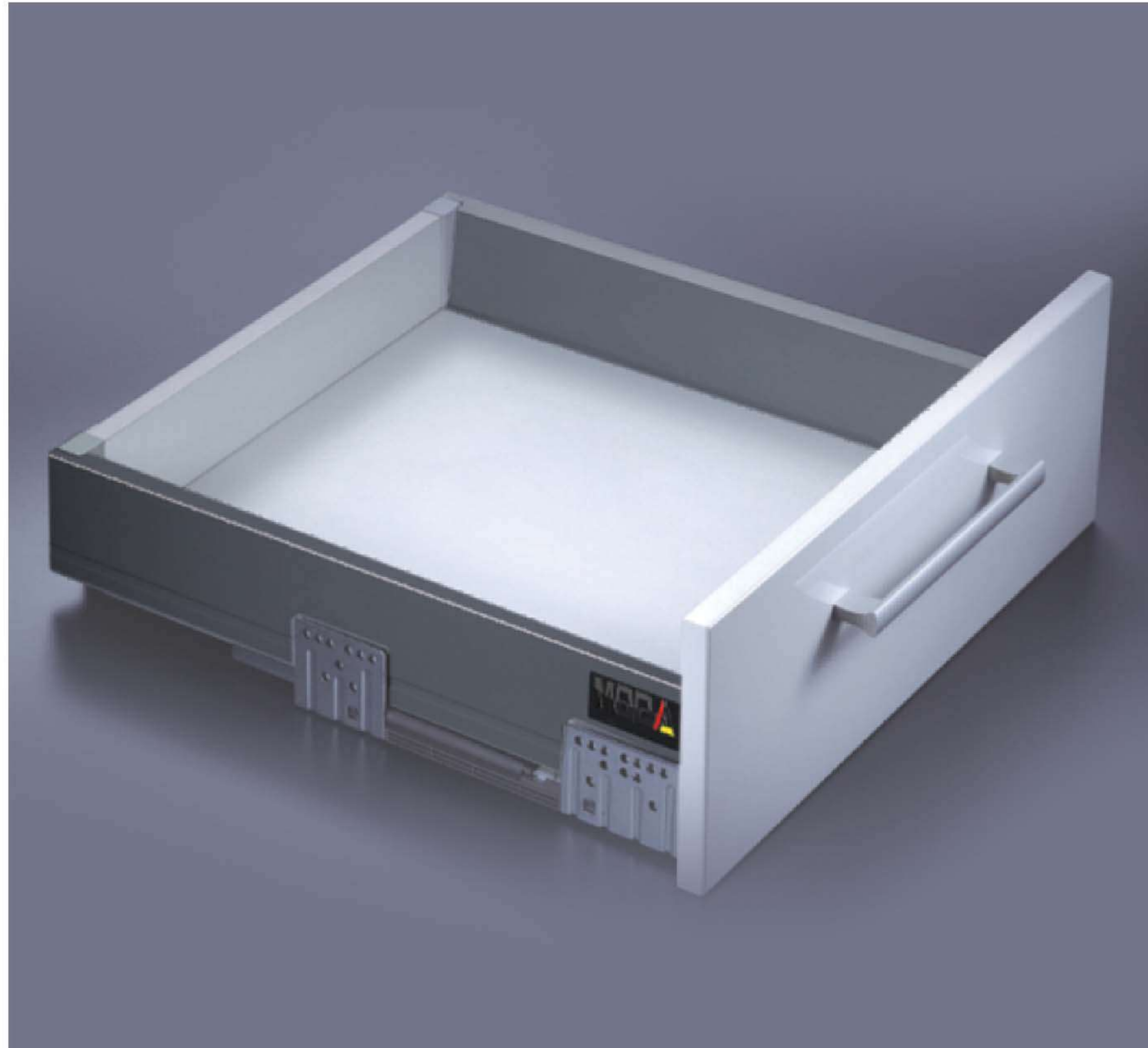

H68

- Affordable, Soft Closing Drawer Mechanism.
- Equipped with Synchronized Slides, made in Germany.
- Recommended for drawer widths upto 900mm.

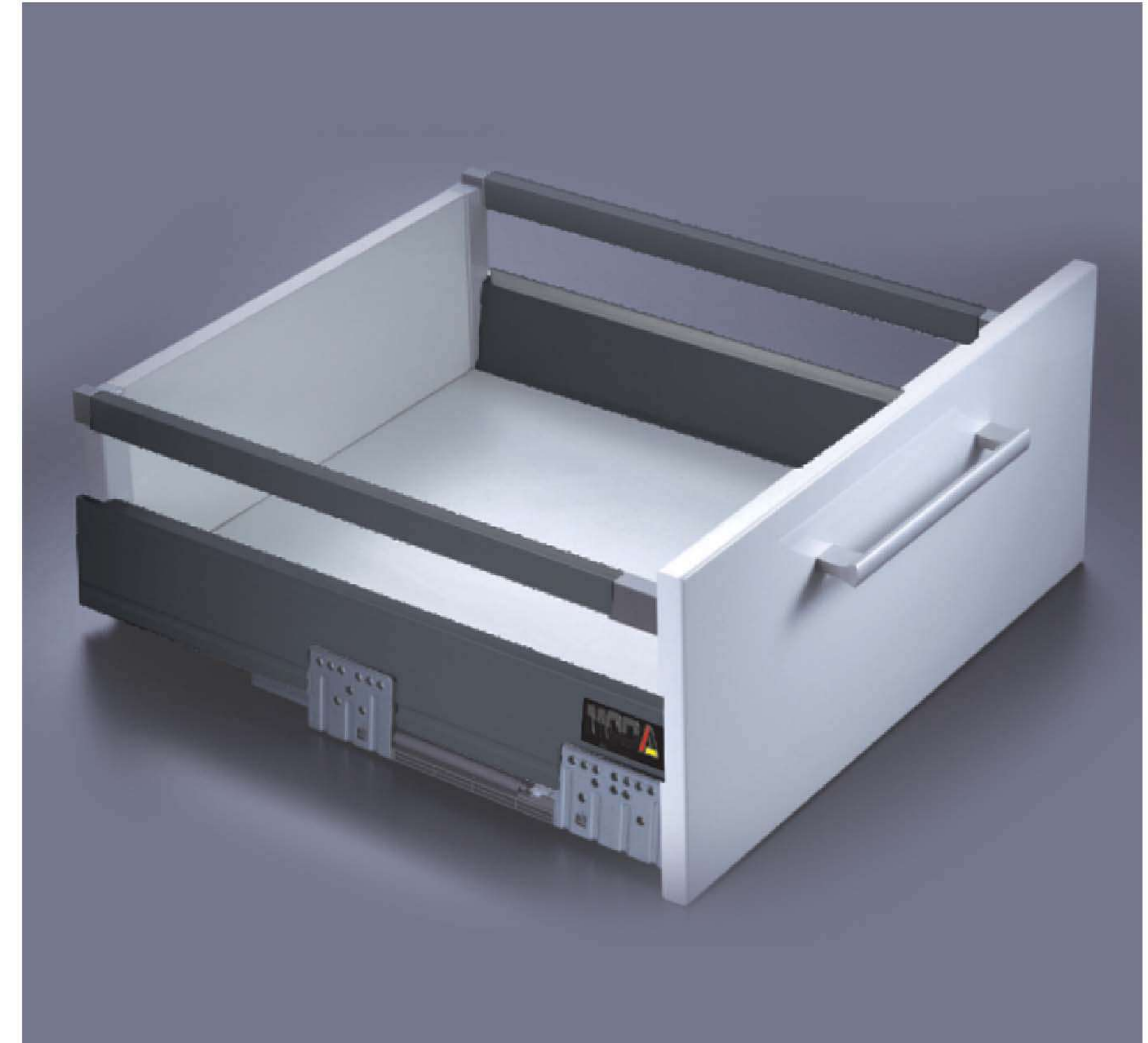

H142

- Affordable, Soft Closing Drawer Mechanism.
- Equipped with Synchronized Slides, made in Germany.
- Recommended for drawer widths upto 900mm.

SLIM BOX

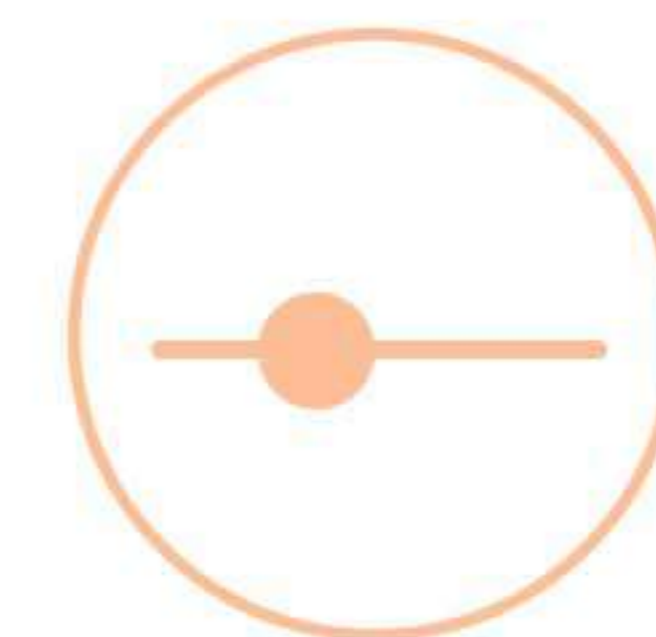
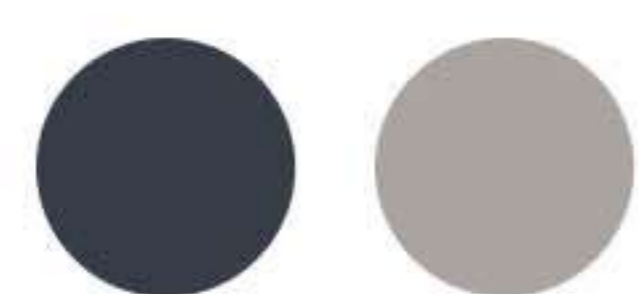

Price range



30 kgs

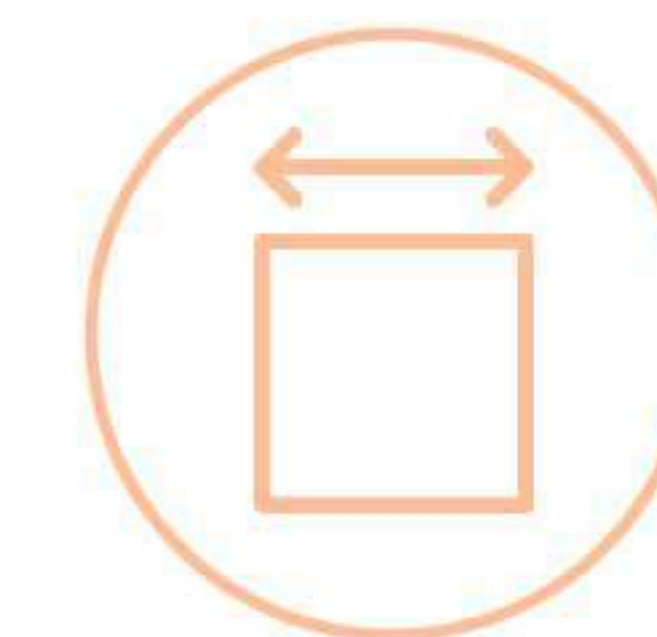

Drawer width
Upto 900mm

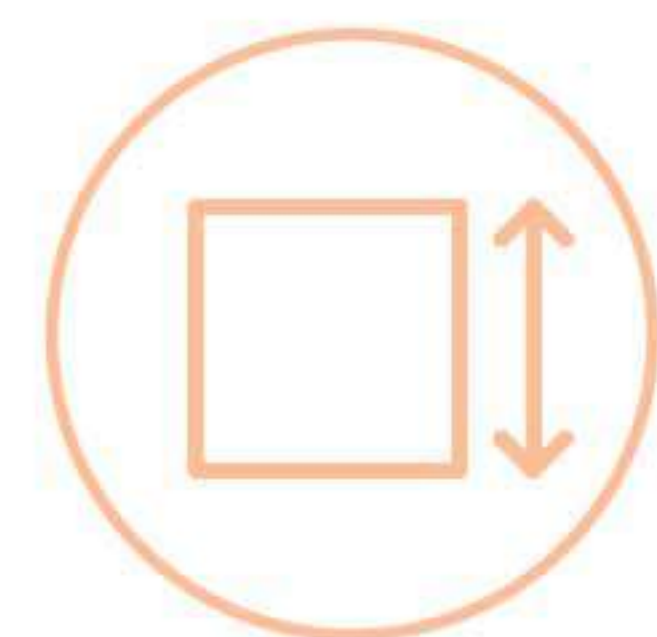

Drawer height
88, 171, 203mm

04

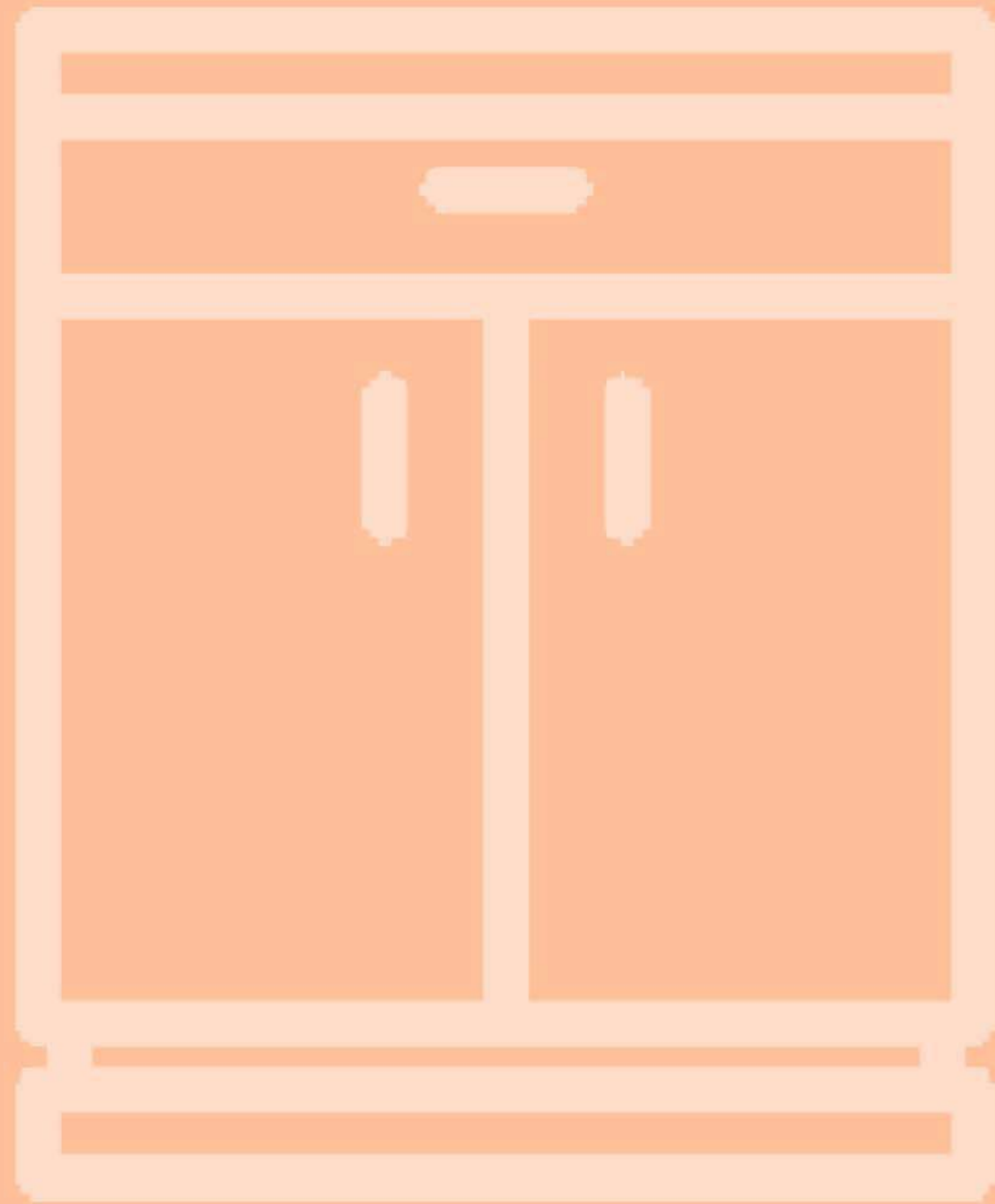

05 Base
Pullouts >>>

06

BOTTLE PULLOUT

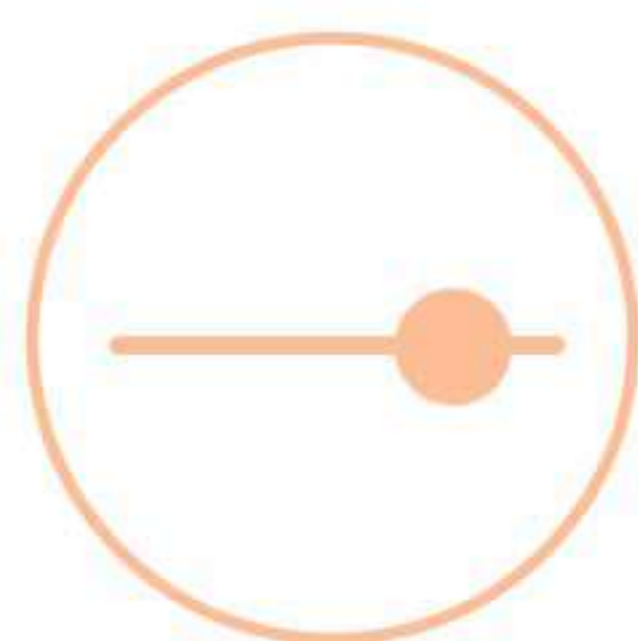

Price range



20 Kgs per tray

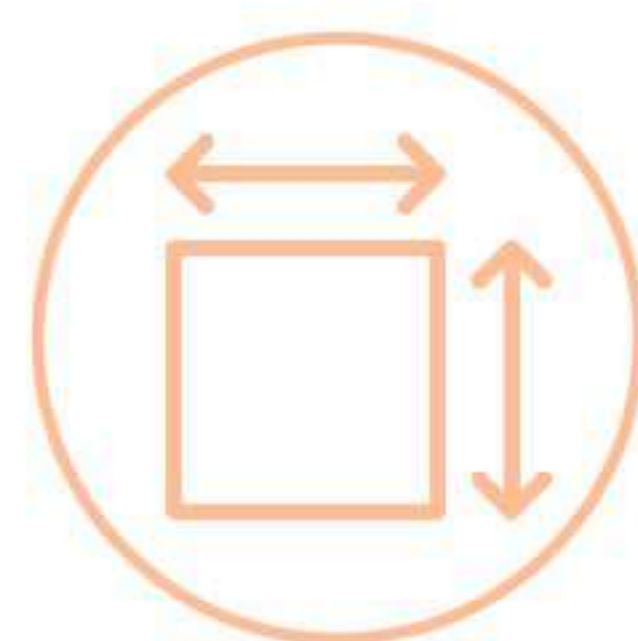

Shutter widths
450mm , 600mm
Inner clearance
900 - 1000mm
Axle Height
1250mm



UNIVERSAL BOTTLE PULLOUT

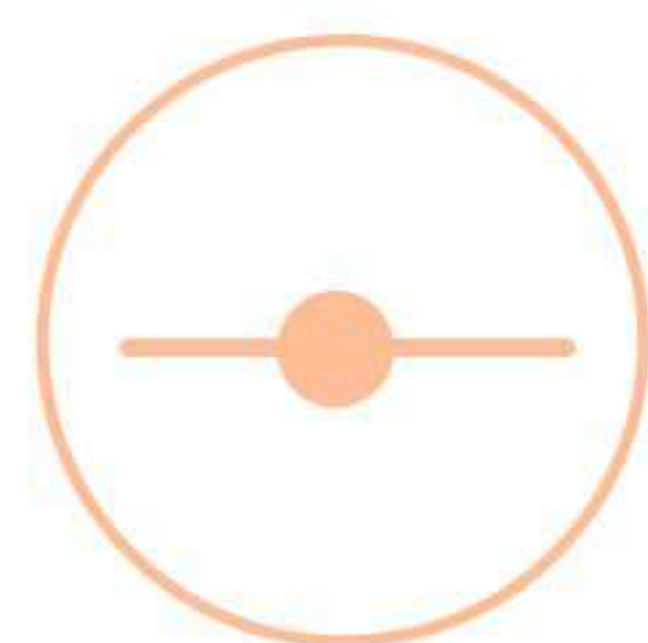

Price range



20 Kgs per
tray

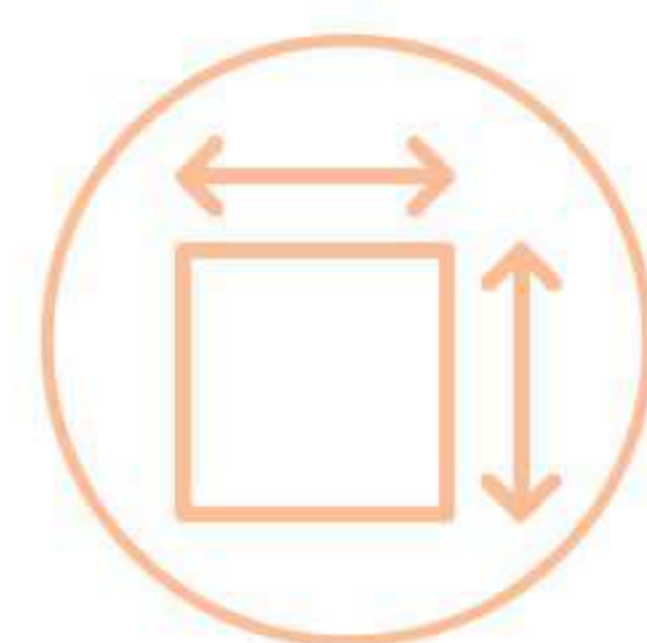

Cabinet widths
200,250, 300 mm
Height
490m

COMFORT II

BASE 250 BASE 300

- Moves smoothly and quietly
- Easily removable shelves
- Special height-adjustable trays
- Option of two/ three trays

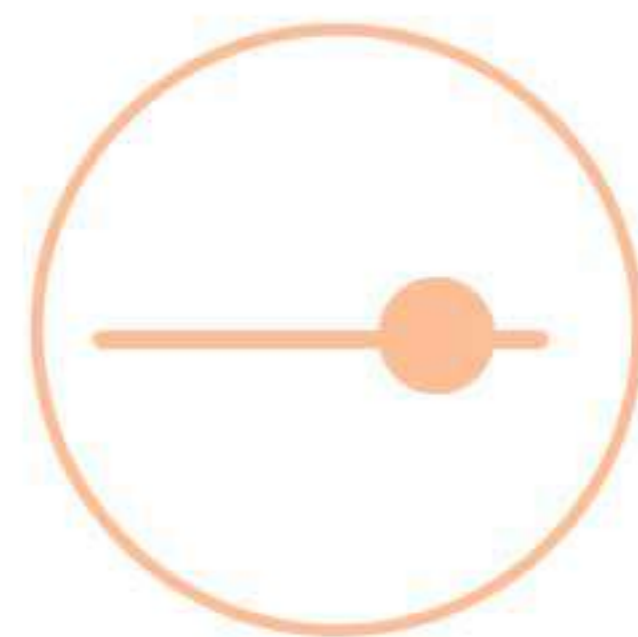

Price range



20 Kgs



Storage

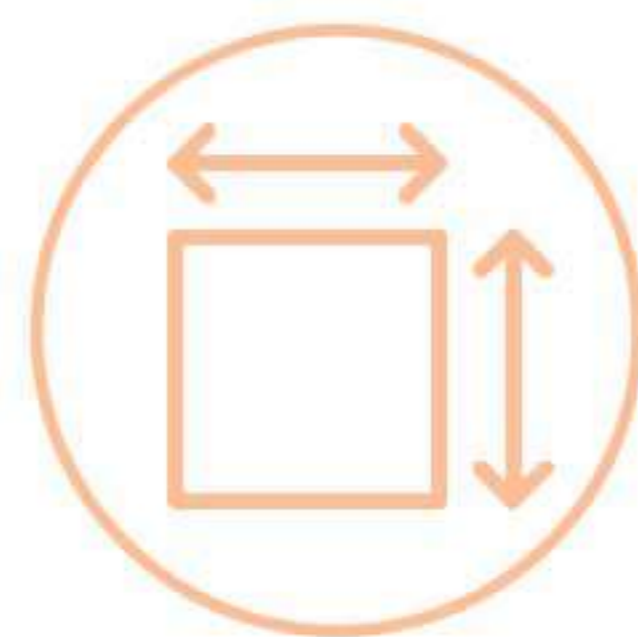

W X D X H
160 X 470 X
662/590

W X D X H
228 X 470 X 662/590



TOWEL RAIL

- Towel Rail with a handy plastic container for hand towels, cloths and sponges.
- Great for small spaces around the sink or cooker.

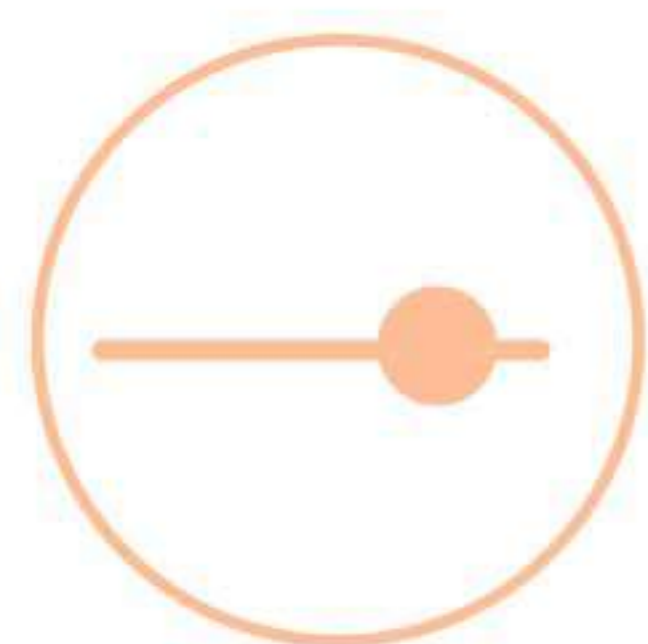

Price range



15 Kgs



Storage

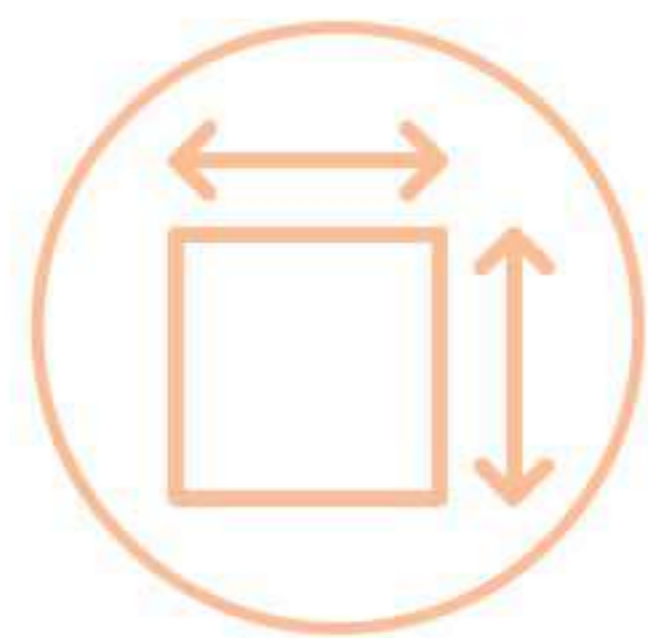

W X D X H
100 X 470 X 580



BASE PULLOUT FLEX

- Accommodates wide bottomed cutlery, bottles and jars.
- Great for small spaces around the sink or cooker.
- Flexible width.

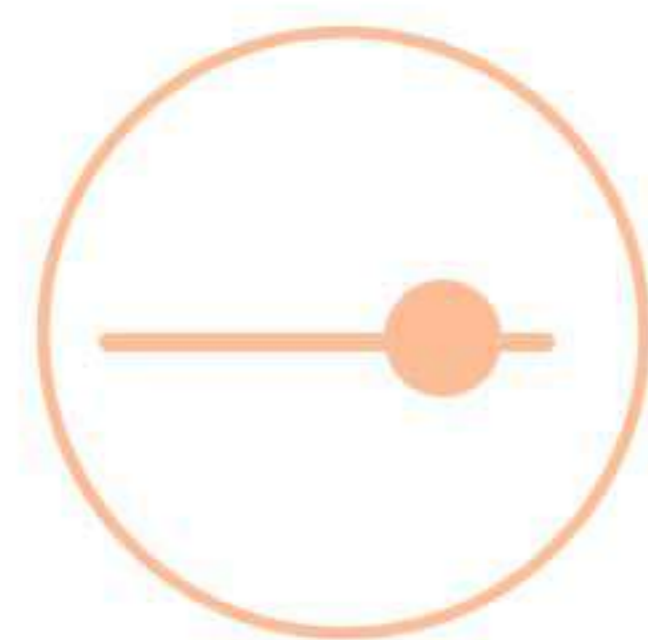

Price range



15 Kgs



Storage

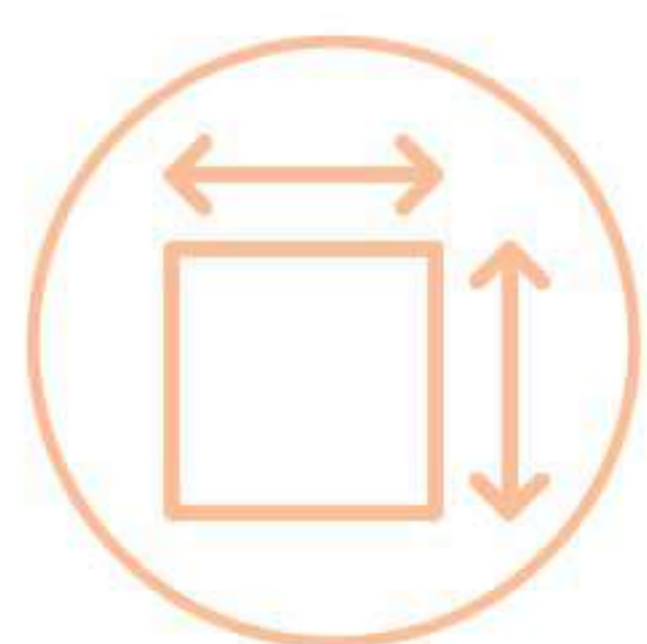

W X D X H
W X 500 X 490



BASE PULLOUT FLEX

- Accommodates wide bottomed cutlery, bottles and jars.
- Excellent pullout for flexible cabinet widths.
- Flexible width.

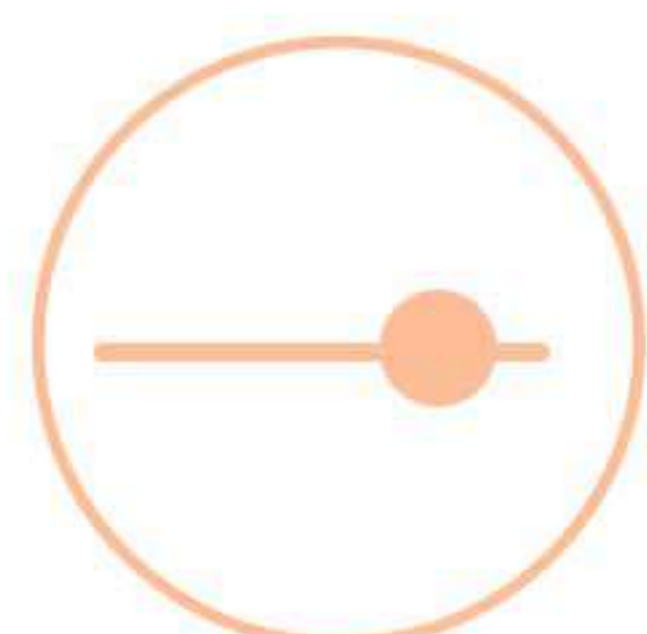

Price range



15 Kgs



Storage

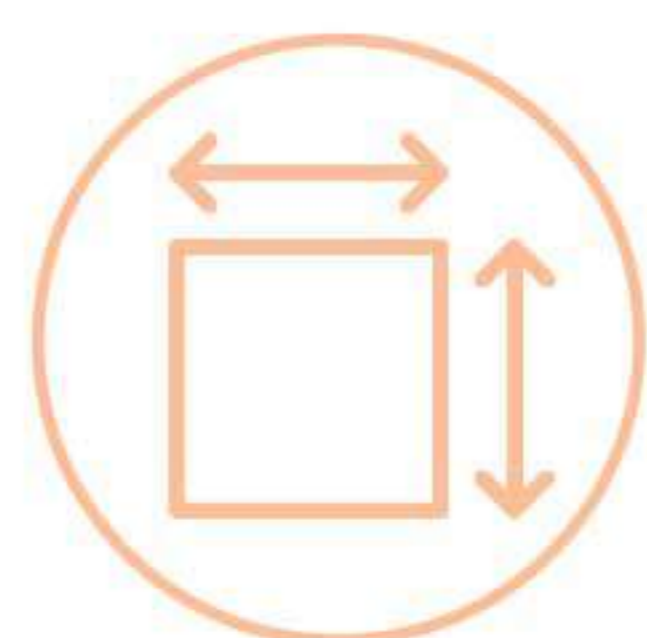

W X D X H
W X 500 X 490



GRANARY STORE

- Both containers can be removed and reassembled.
- Great to store provisions, pulses and grains
- Bottom mount

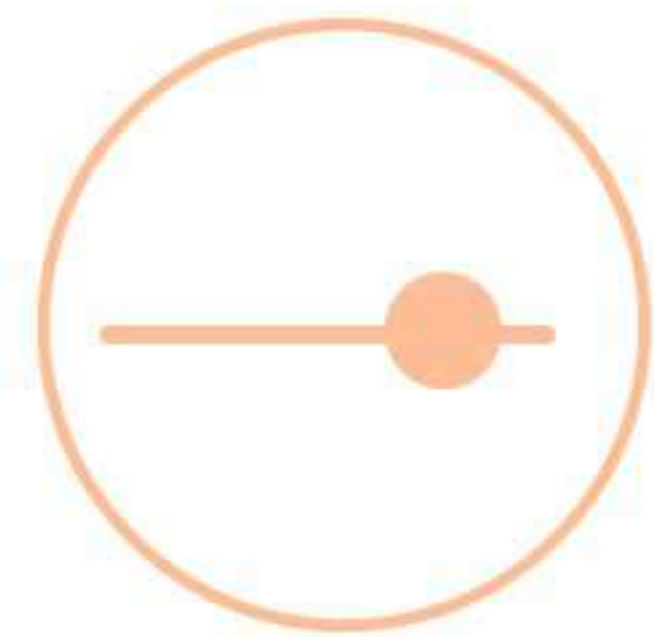

Price range



2 X 29 lts



Grocery

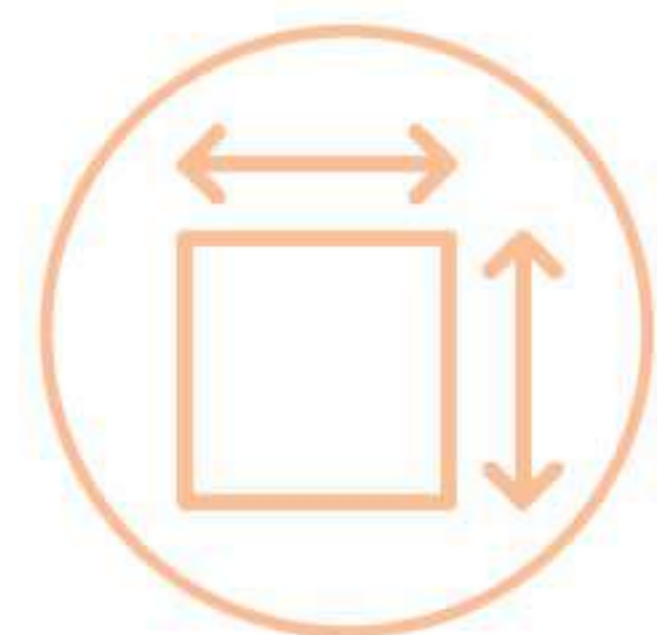

W X D X H
450 X 530 X 523



PLASTIC WICKER

- Available in three different heights.
- Made with real wicker.
- Easy to pullout with runner slides
- Easy to clean

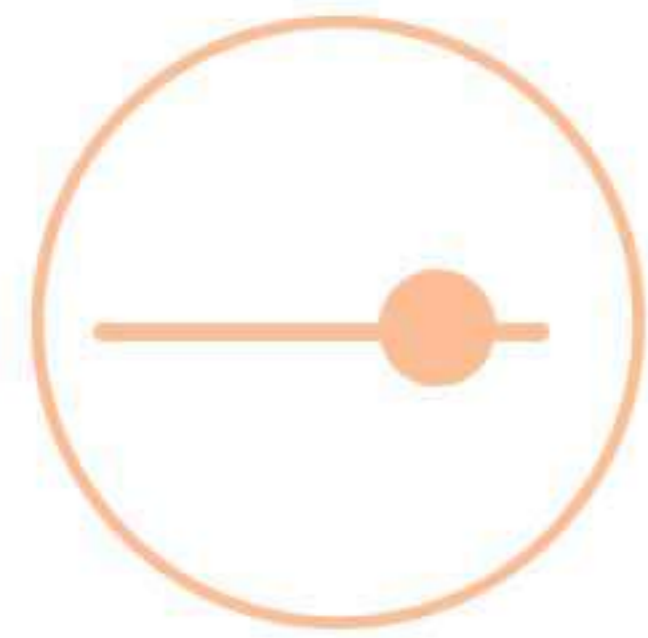

Price range



20 Kgs

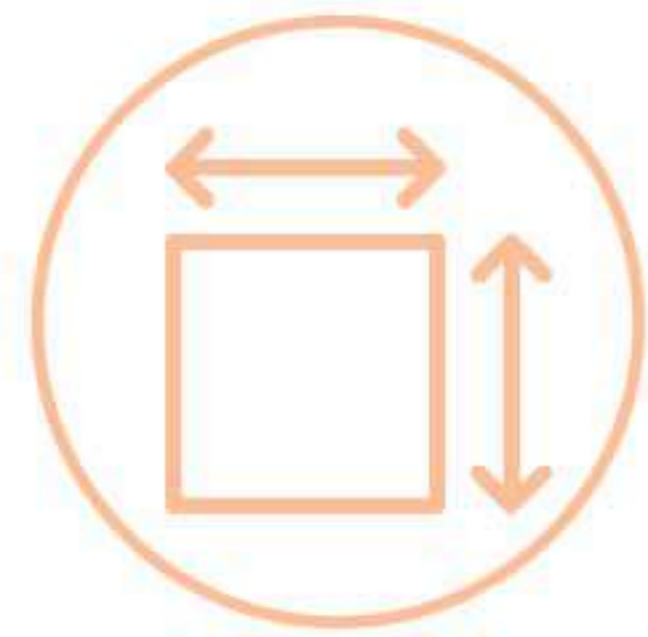

Cabinet width
450

Product dimension
414 X 500 X
100/150/200

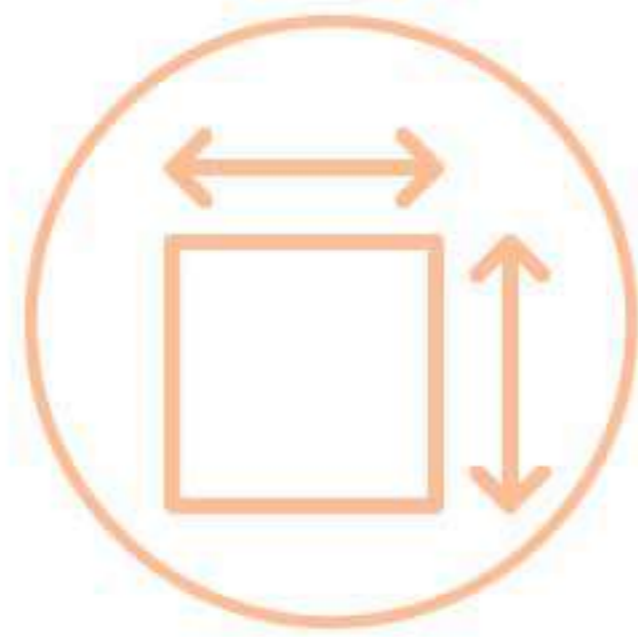

Cabinet width
600

Product dimension
564 X 500 X
100/150/200



COUNTRYINE WICKER

- Perfect to aerate non-refrigeratable veggies
- Inbuilt handle.
- Easy to pullout with runner slides
- Easy to clean

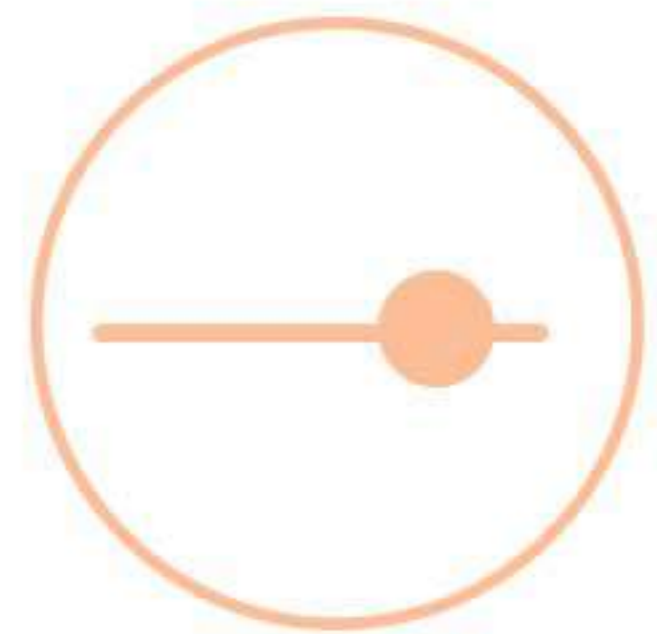

Price range



20 Kgs

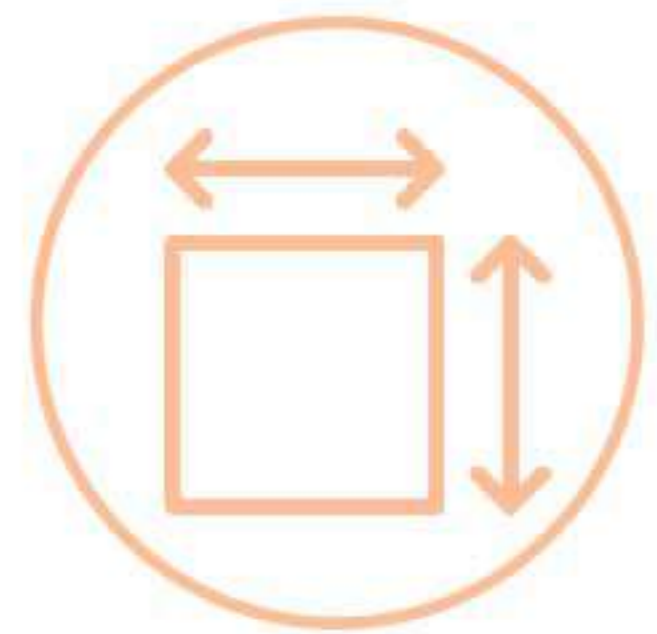

Cabinet width
450
Product dimension
414 X 500 X 200

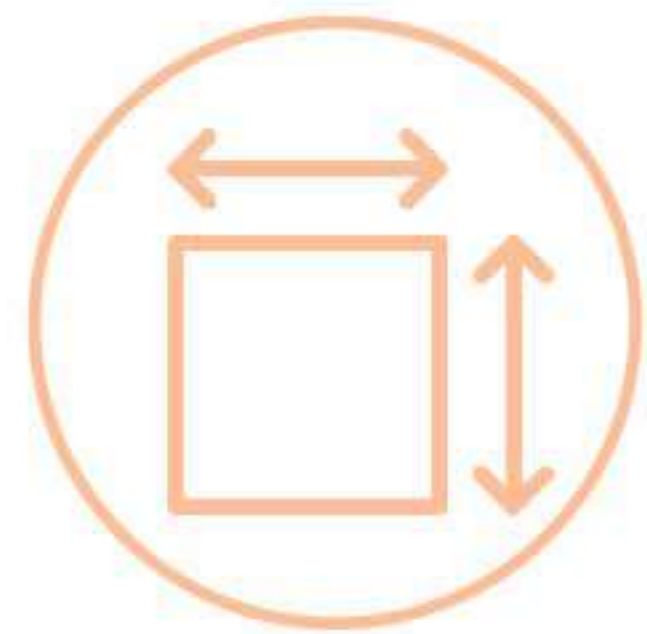

Cabinet width
600
Product dimension
564 X 500 X 200



COOKING AGENT

- Stores spices, oils and sauces, chopping boards and knives.
- Occupies 1 feet of base cabinet space.
- All adjustable trays hooked to rails.

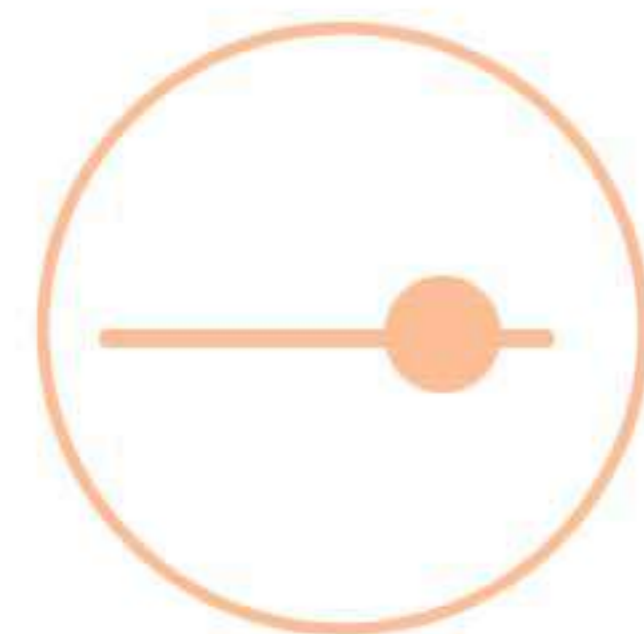

Price range



16 Kgs



Cabinet width
300mm

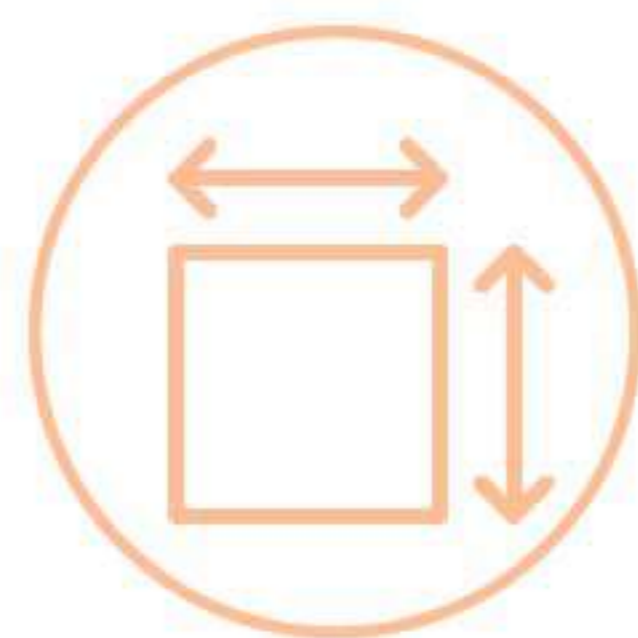

Product dimension
260 X 489 X 625mm



TOPFLEX

- Extra space for working or just to enjoy a quick snack
- Fits kitchens, studies and other work spaces

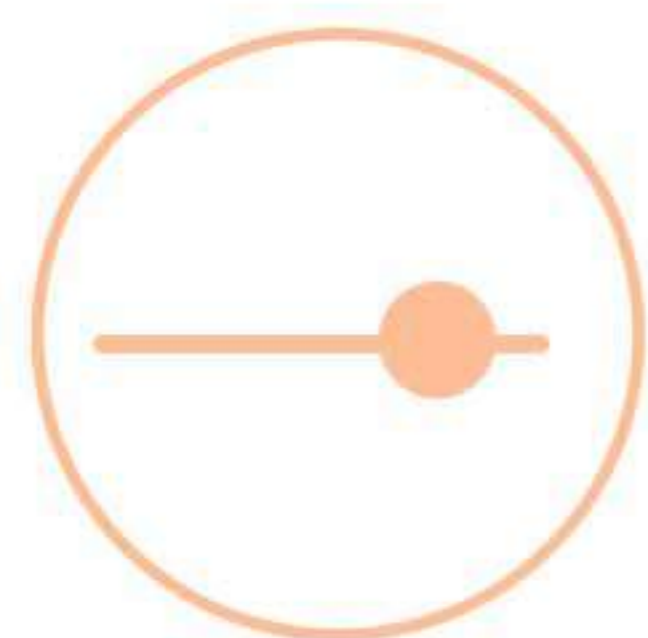

Price range



15 Kgs

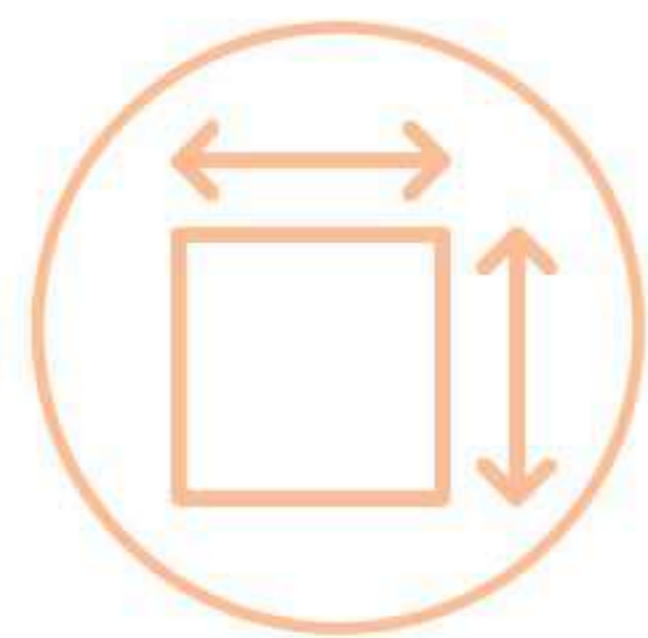

Flexible width
Extended length
- 810

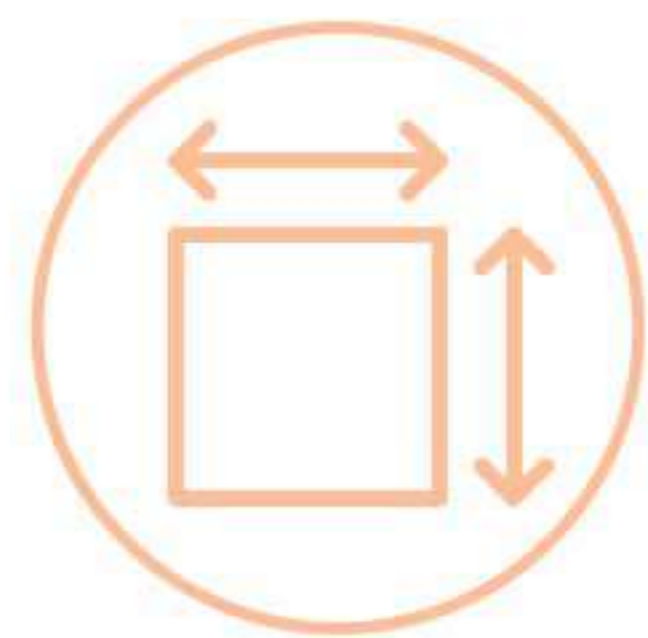

W X D X H
W X 500 X 150





KESSEBÖHMER



05

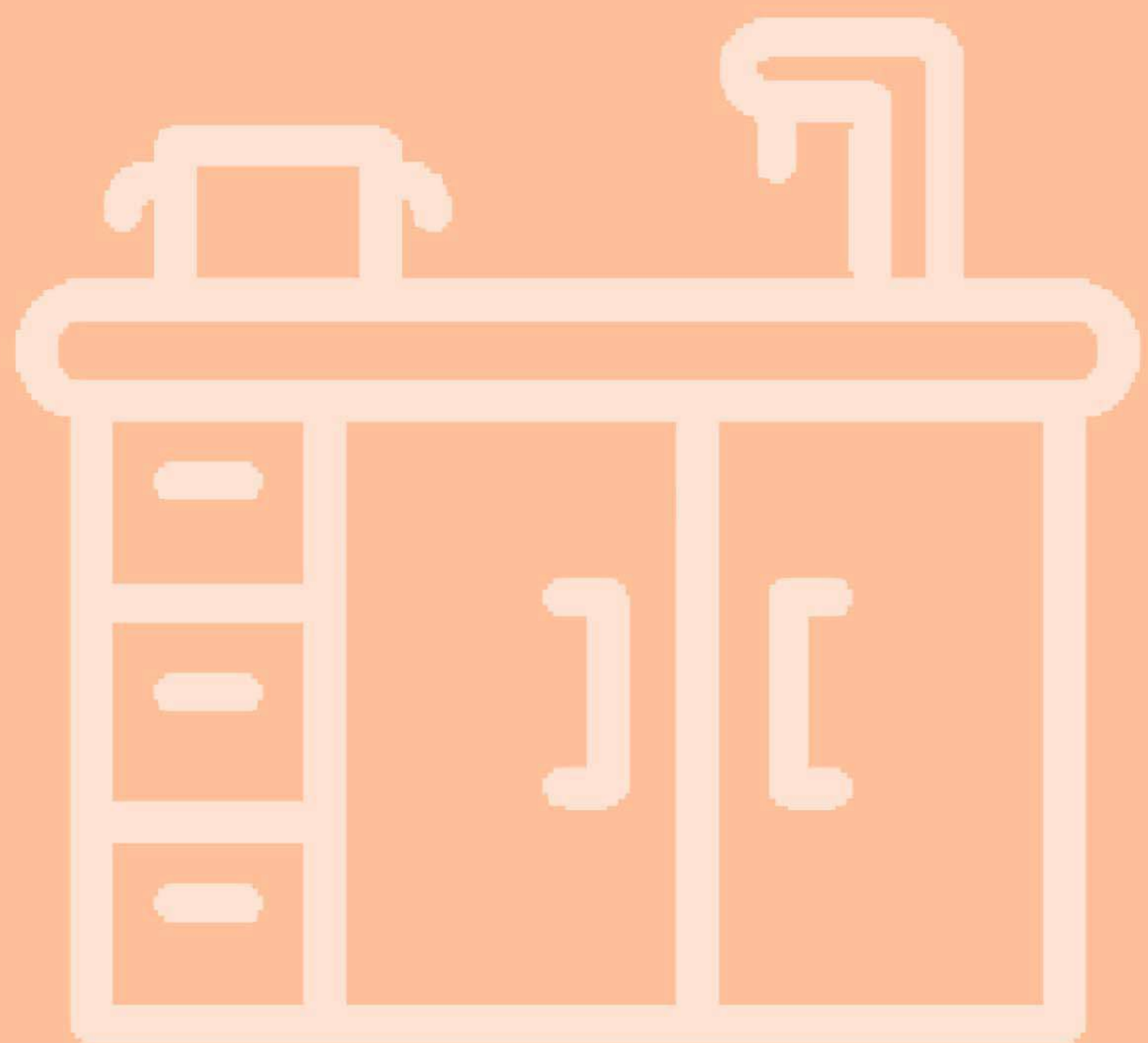

06 Undersink
Storage
Solutions >>

07

PORTERO

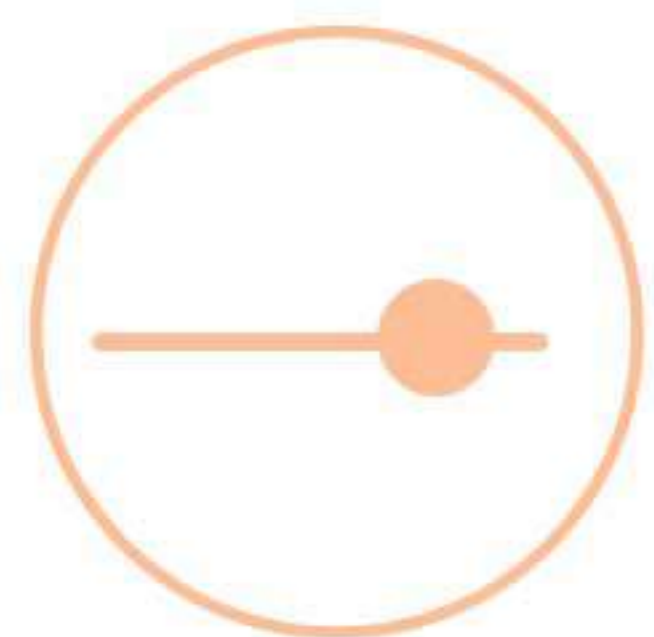

Price range



Utensils



25 Kgs per tray

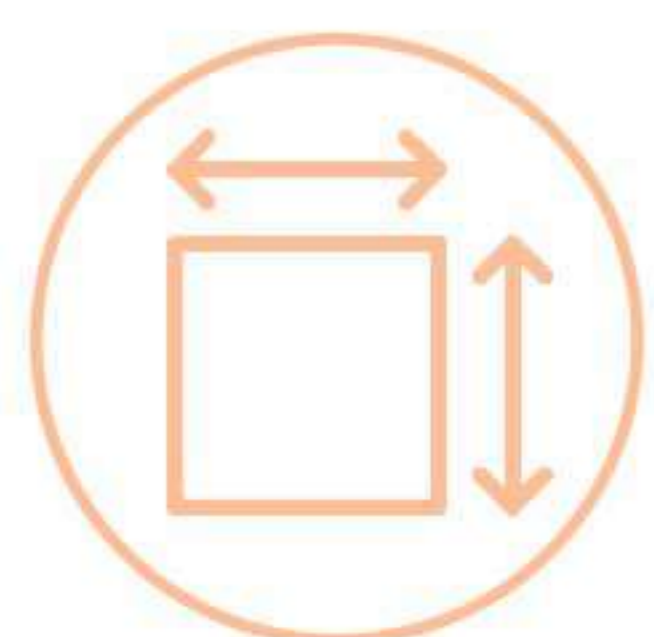

Product Dimension

W X D X H

- Portero (Set 1)
150 X 490 X 475
- Portero (Set 2)
270 X 490 X 475
- Portero (Set 3)
270 X 490 X 500



CARRY

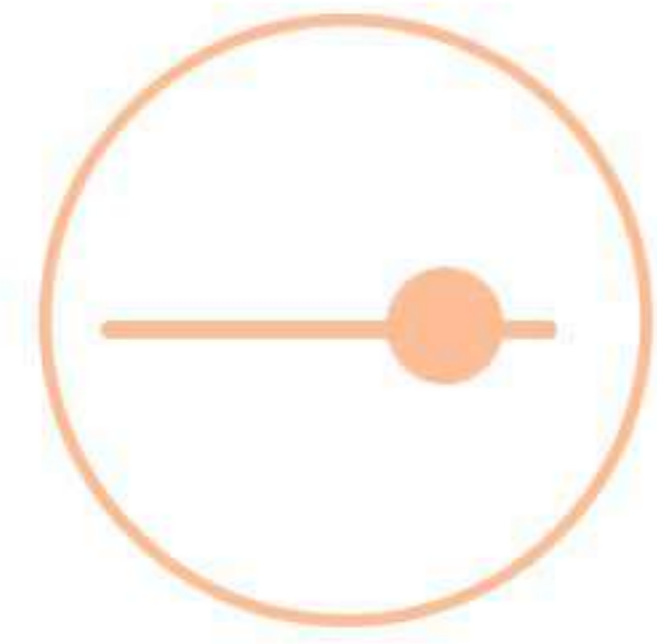

Price range



Utensils



25 Kgs per tray

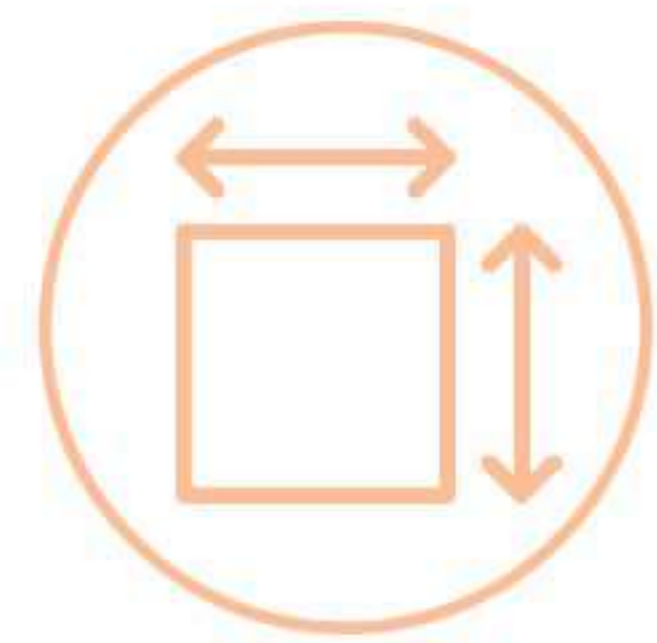

Product Dimension
W X D X H
400 - 600 X 459 X
395



TERZET

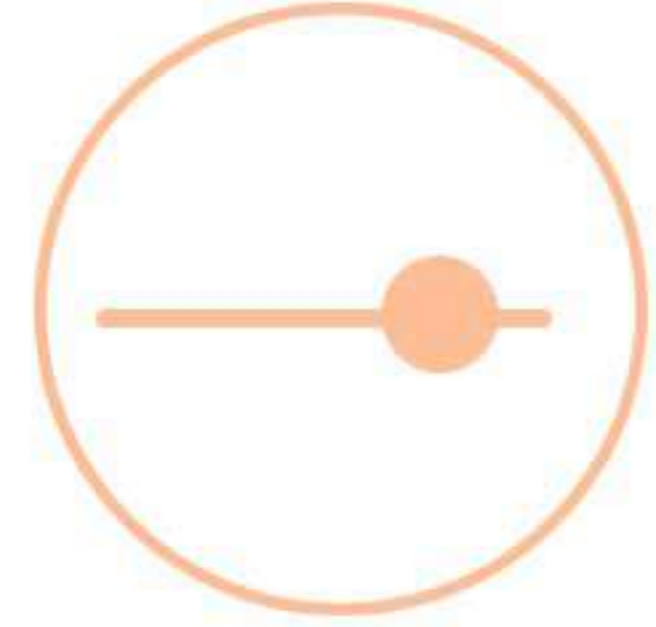

Price range



Utensils



25 Kgs per tray

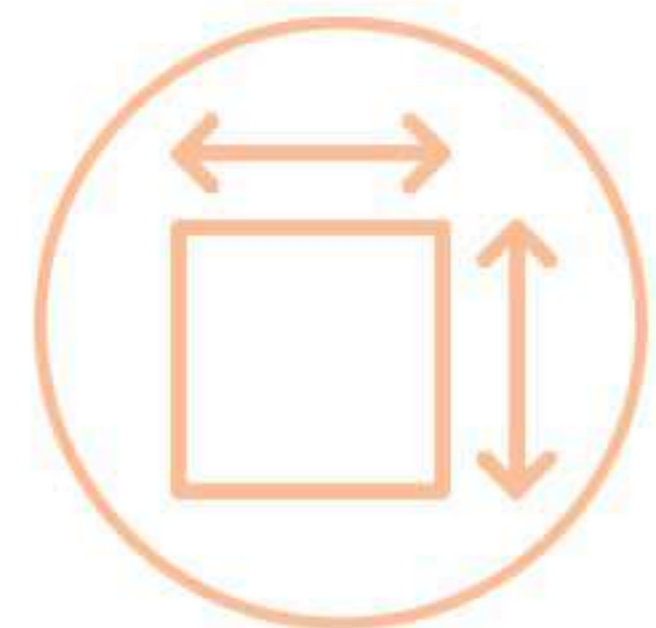

Product Dimension
W X D X H
251 X 482 X 400



TERZET



MONO BIN

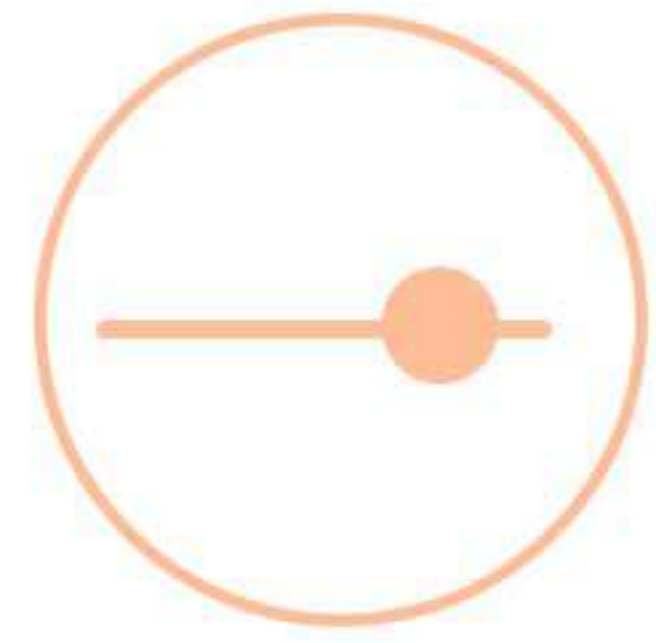

Price range



Utensils



25 Kgs per tray

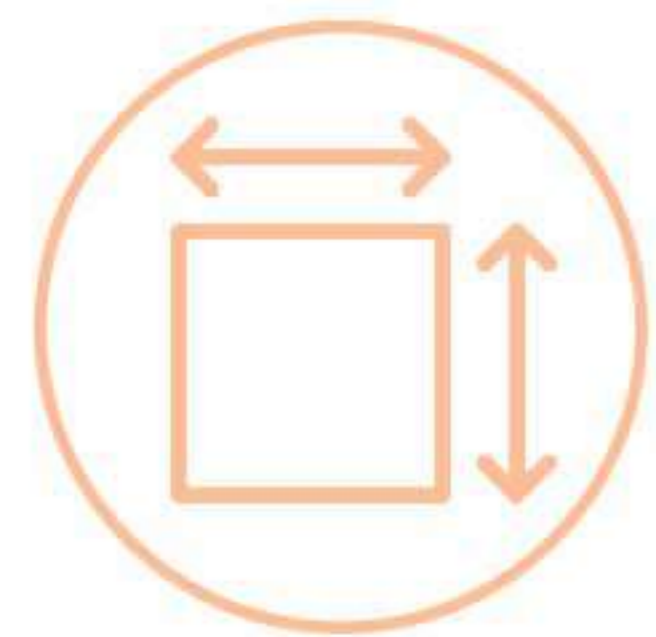

Cabinet width
400 mm

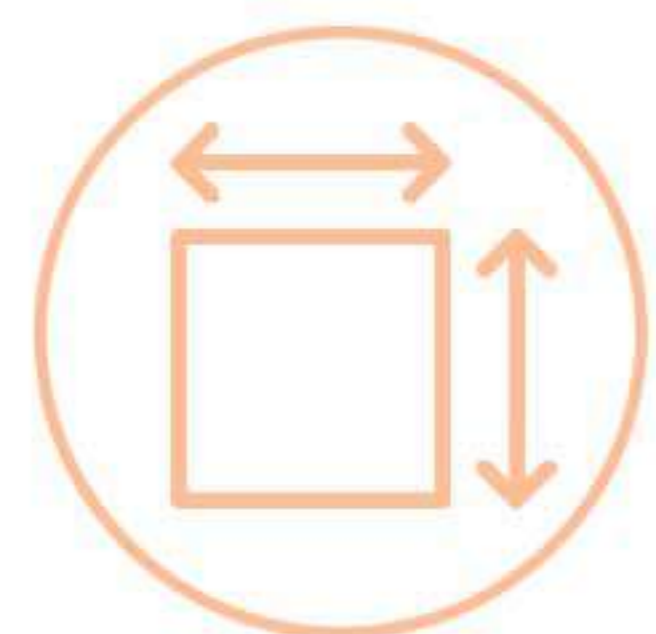

Product Dimension
W X D X H
290 X 340 X 365



DUO BIN

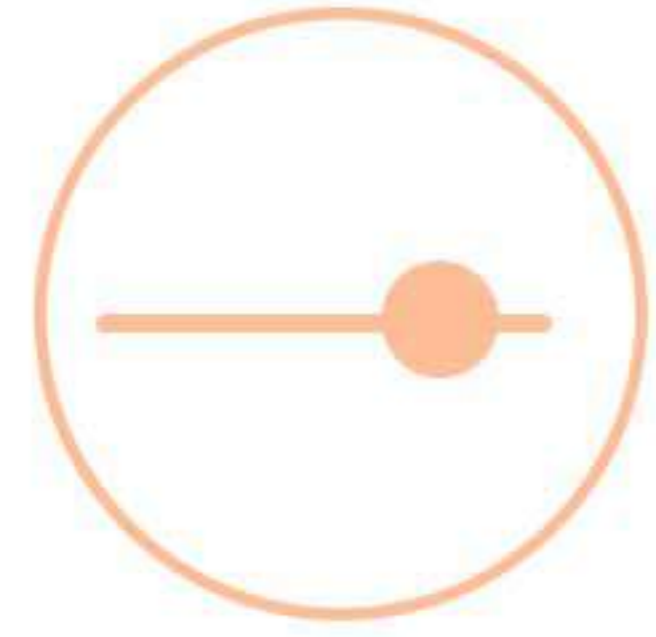

Price range



Utensils



25 Kgs per tray

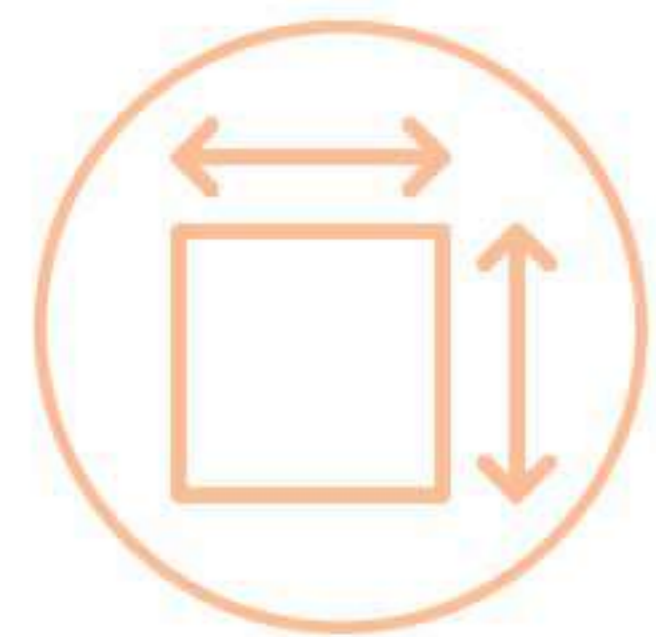

Cabinet width
400 mm

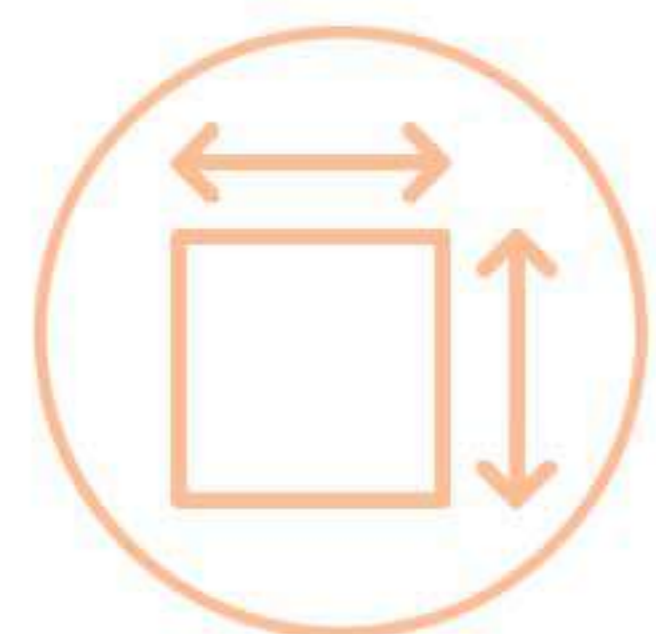

Product Dimension
W X D X H
290 X 340 X 365



PESOLO UTILITY TRACK

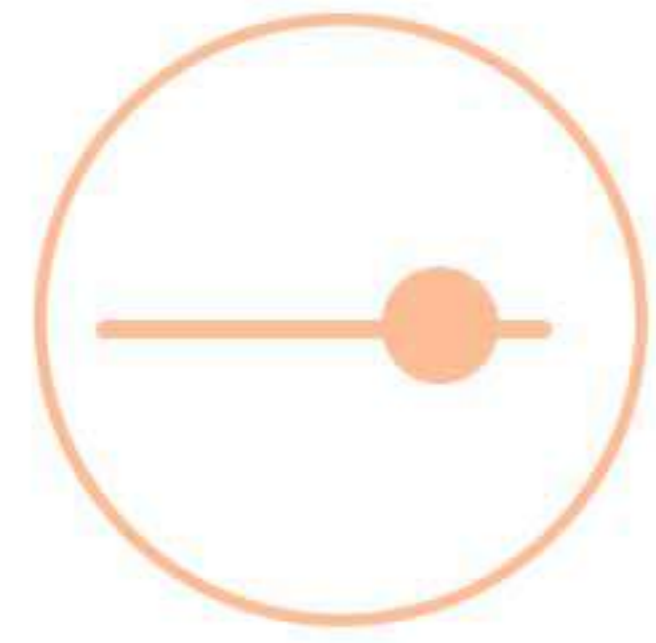

Price range



Utensils



25 Kgs per
tray



Cabinet width
400 mm

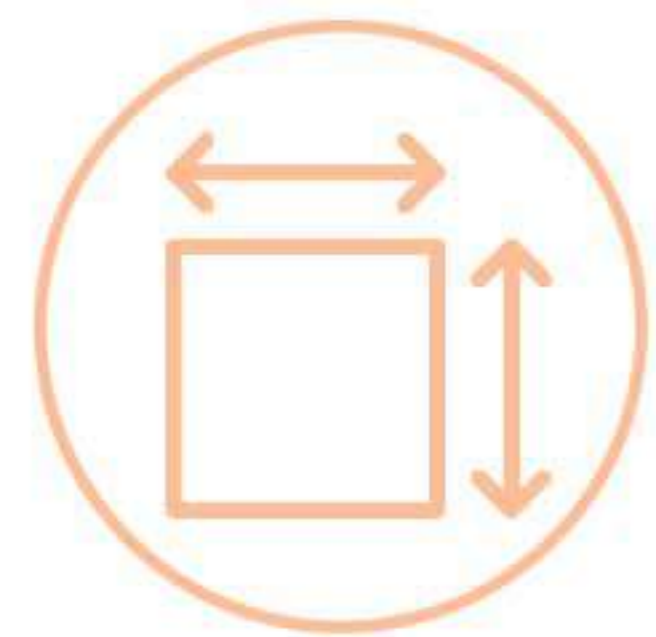

Product Dimension
W X D X H
290 X 340 X 365



06

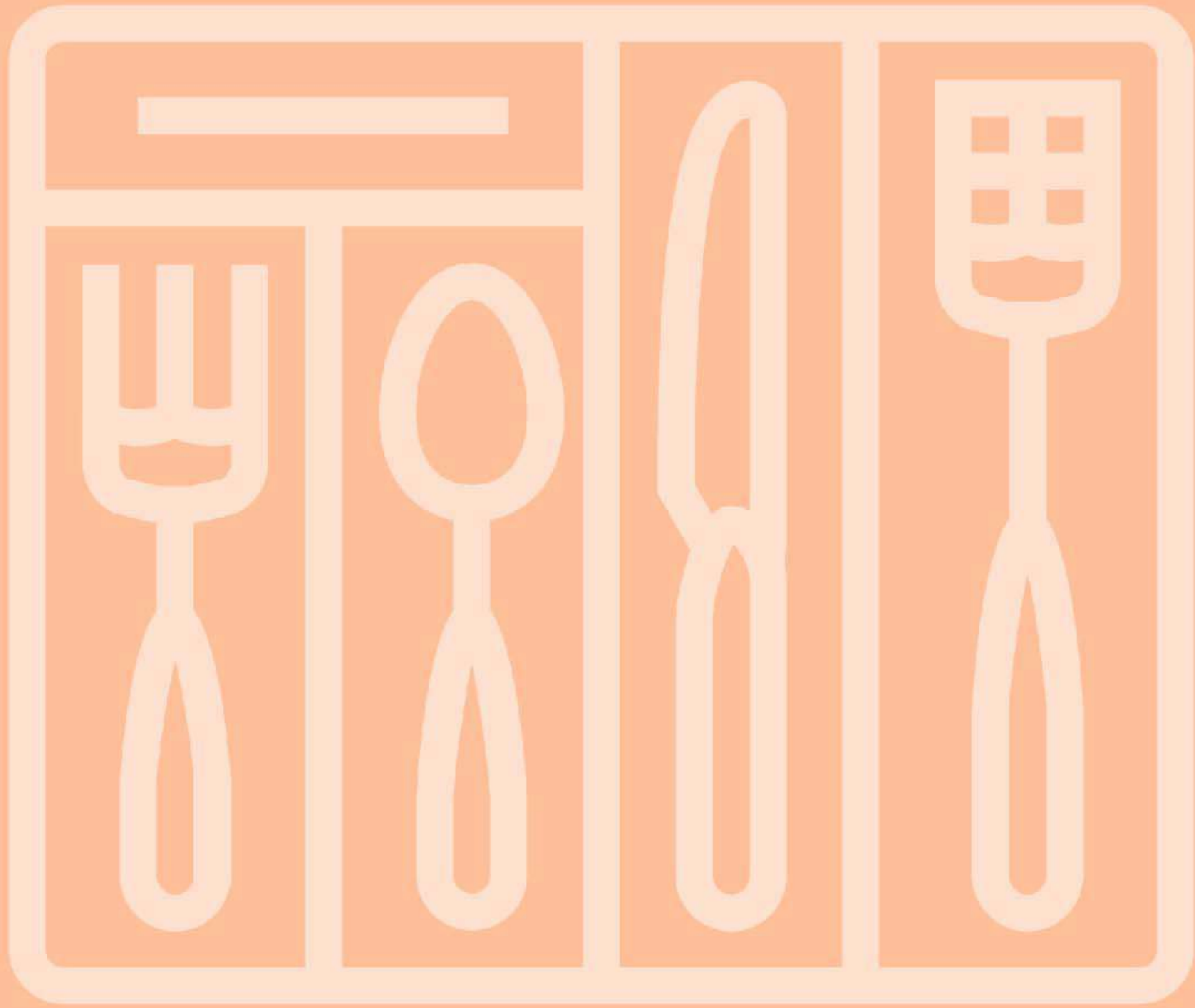

07 Cutlery
Organiser >>

08

PLATE INSERTS

GLASS & PLATE RACKS

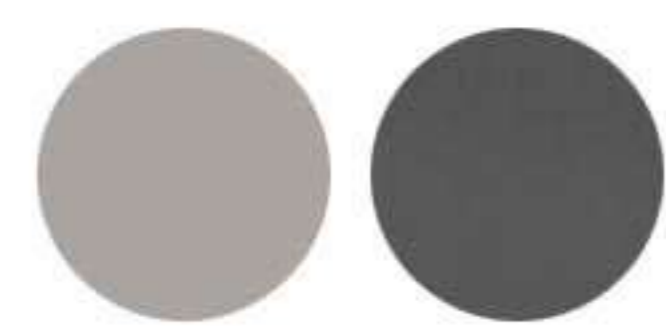

FINISHES
Titanium
strip
steel

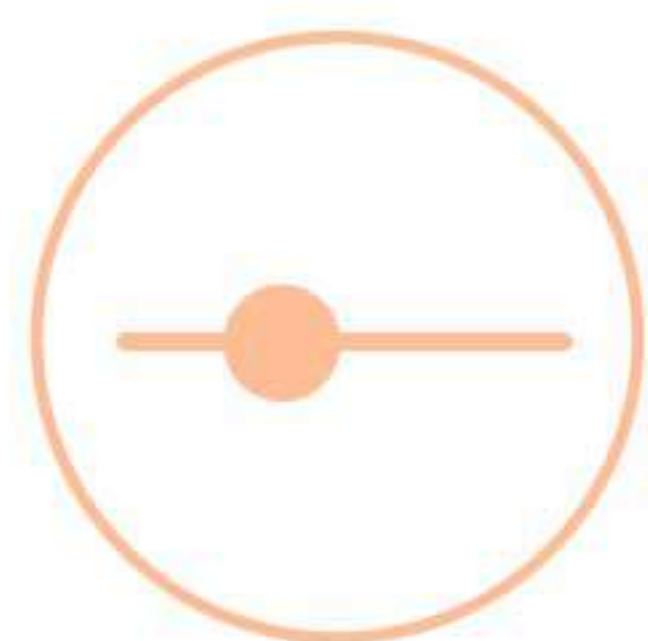

Price range



Cabinet width
600mm,
900mm



CUTLERY INSERTS

MOVE

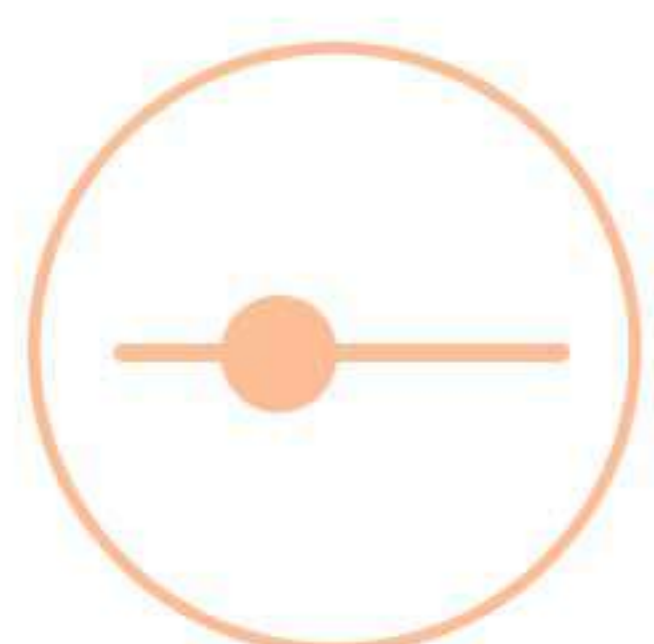

Price range



Cabinet width
450mm,
600mm,
900mm



CUTLERY INSERTS

Cusio



Cabinet width
450mm,
600mm,
900mm

Trendz

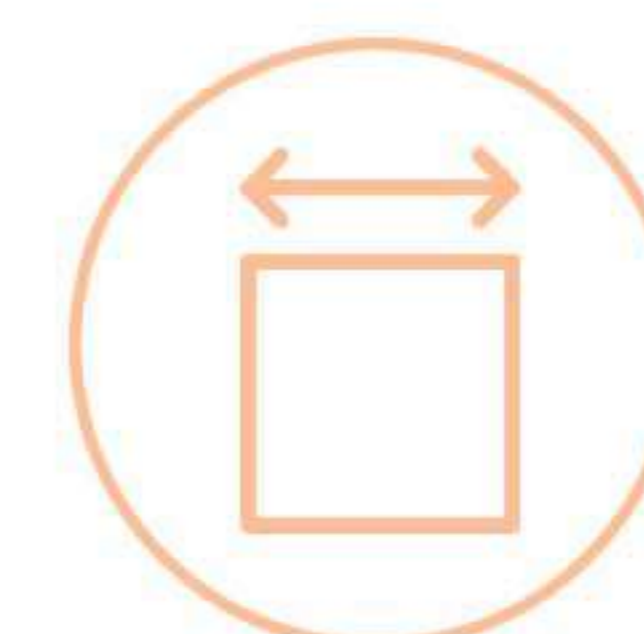

Cabinet width
450mm,
600mm,
900mm

TAVINEA SORTO

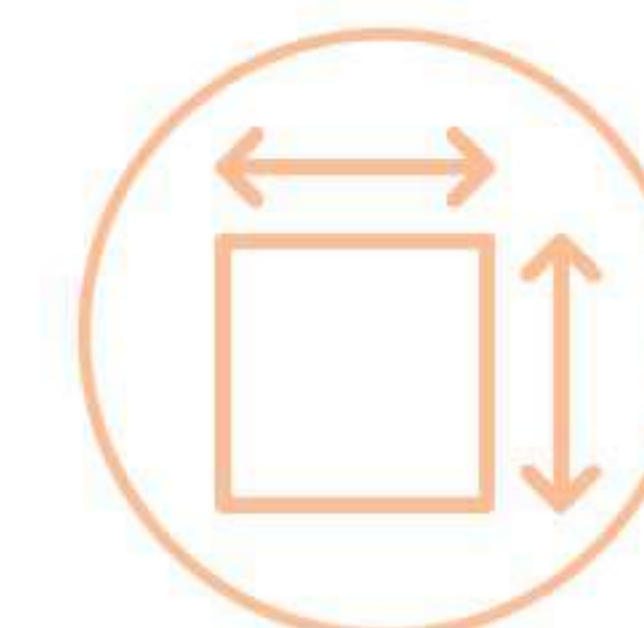

500 D 186mm width
500 D 276mm width

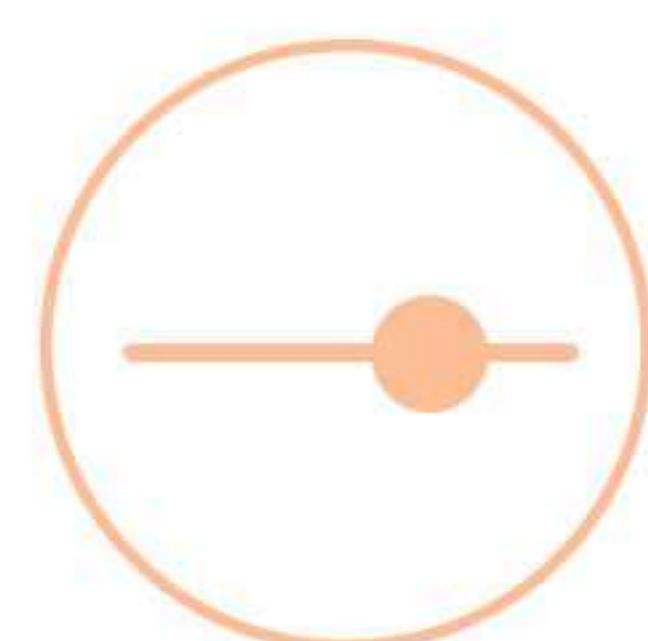

Price range



Cutlery Holders



FOIL CUTTER



KNIFE HOLDER

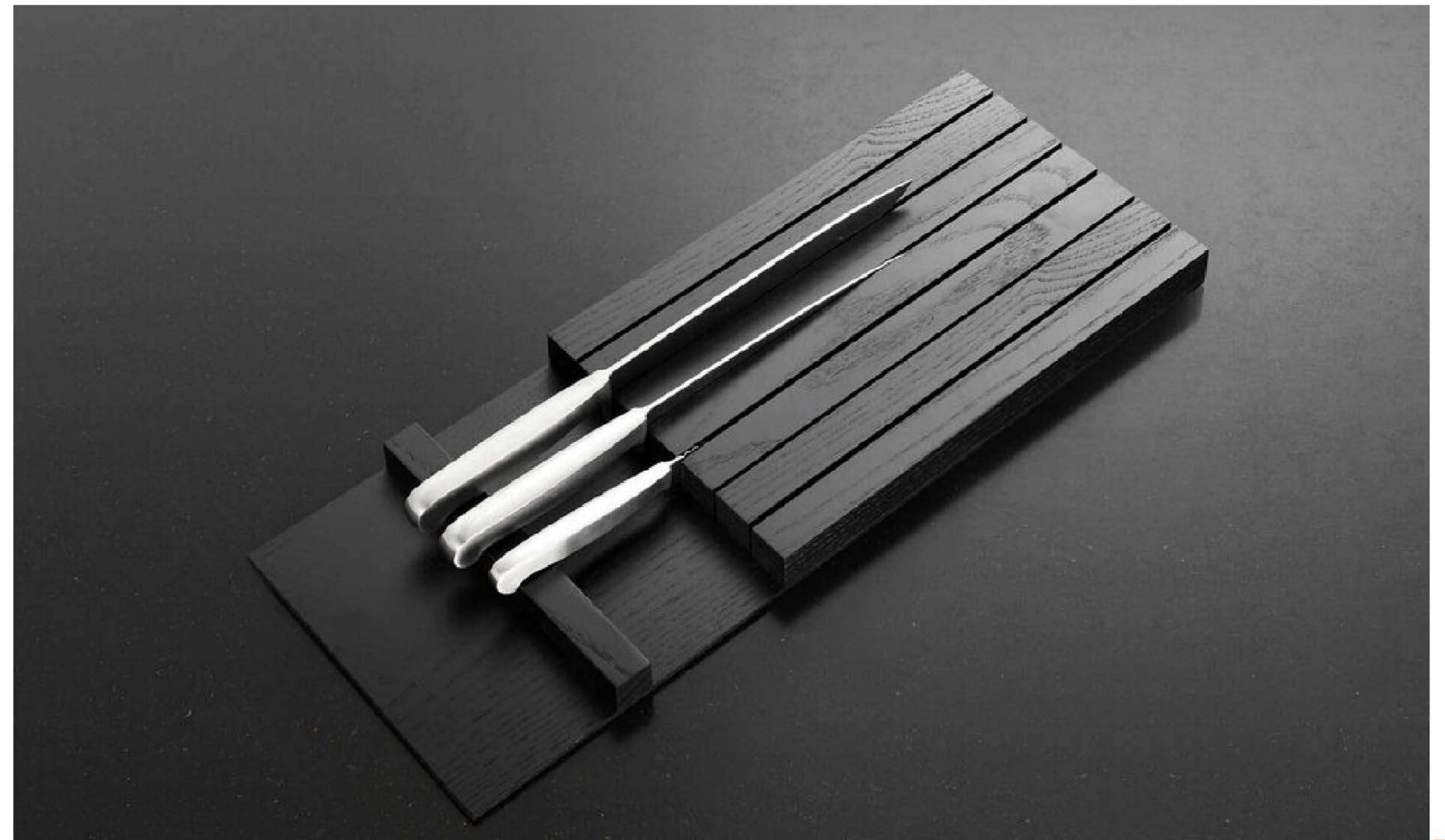

SS CUTLERY ORGANISERTRAY

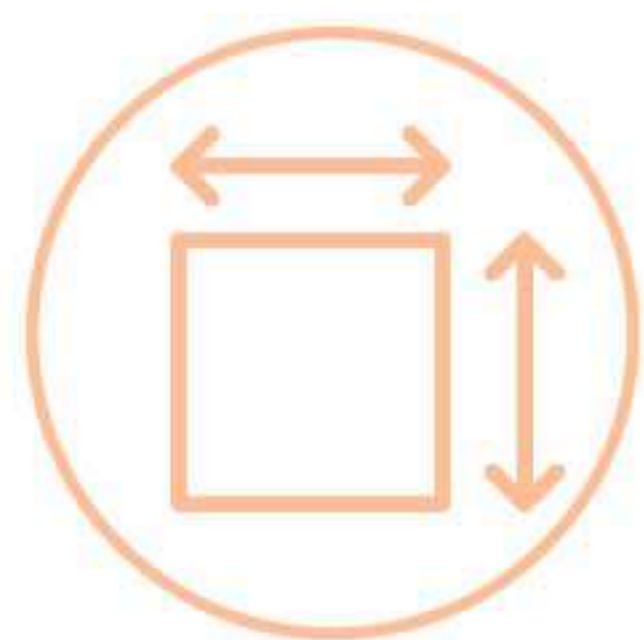

Width 360, 410, 460, 510 mm x
Depth 500mm x Height 67mm



CANISTER 250GMS

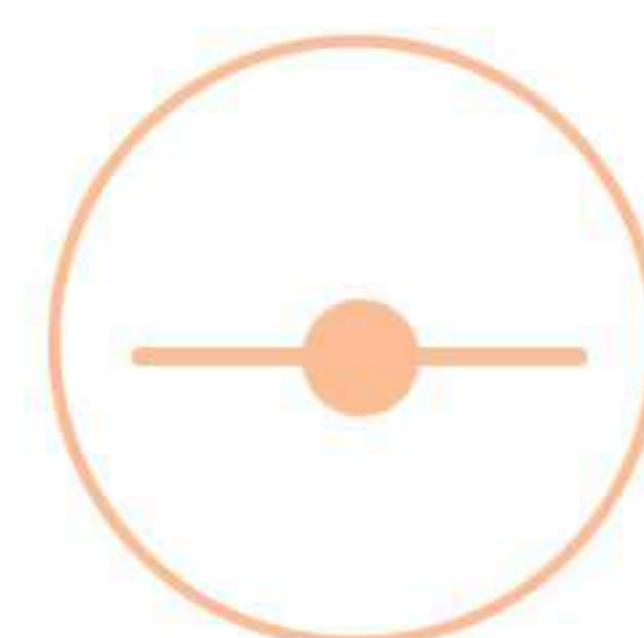

Price range



250 gms



Width
450mm,
600mm

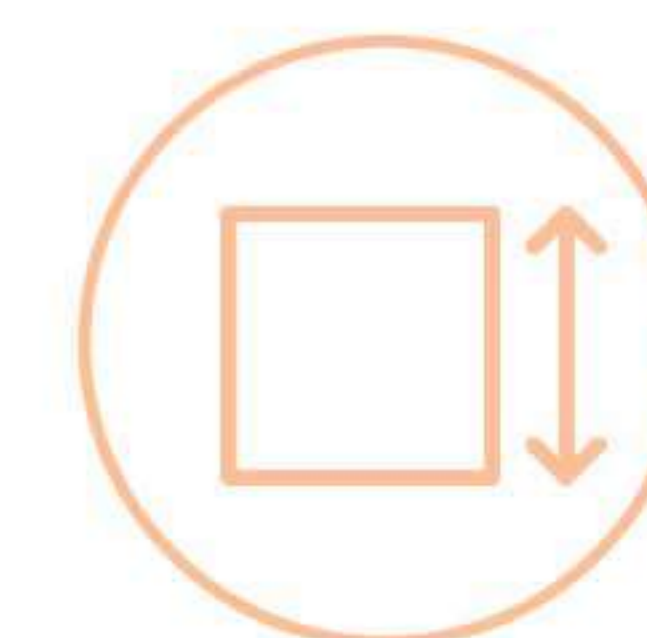

Height
Drawer Height
5" and above

CANISTER 10000 GMS

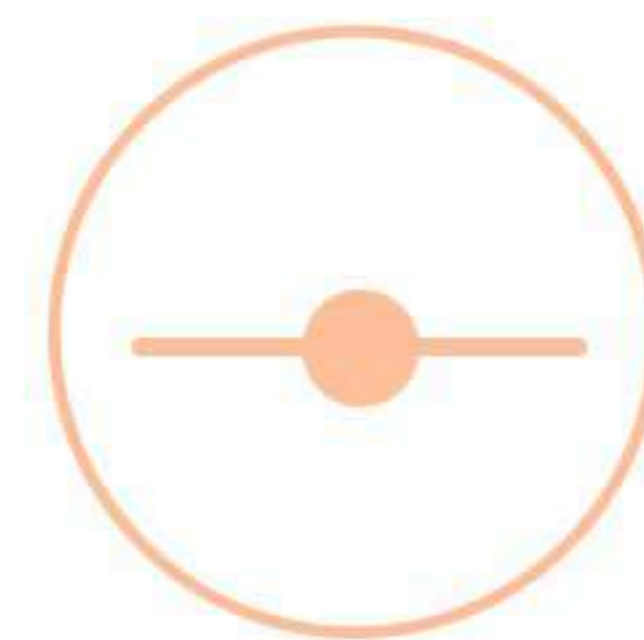

Price range



1000 gms

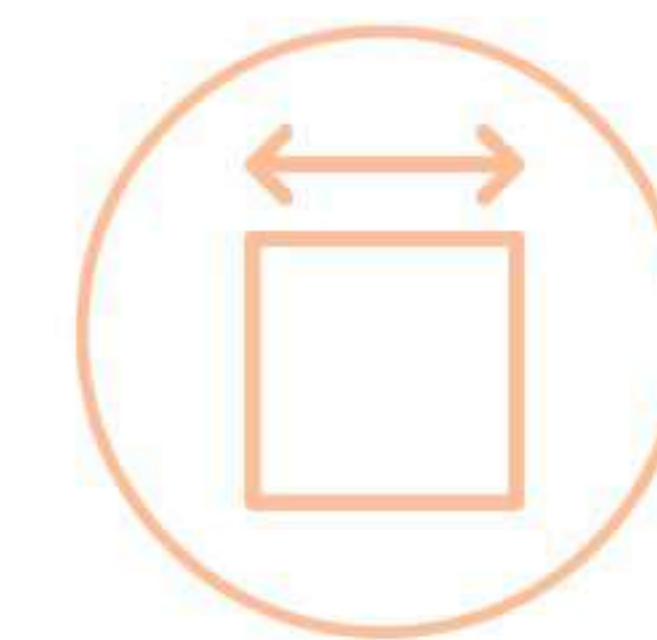

Width
450mm,
600mm

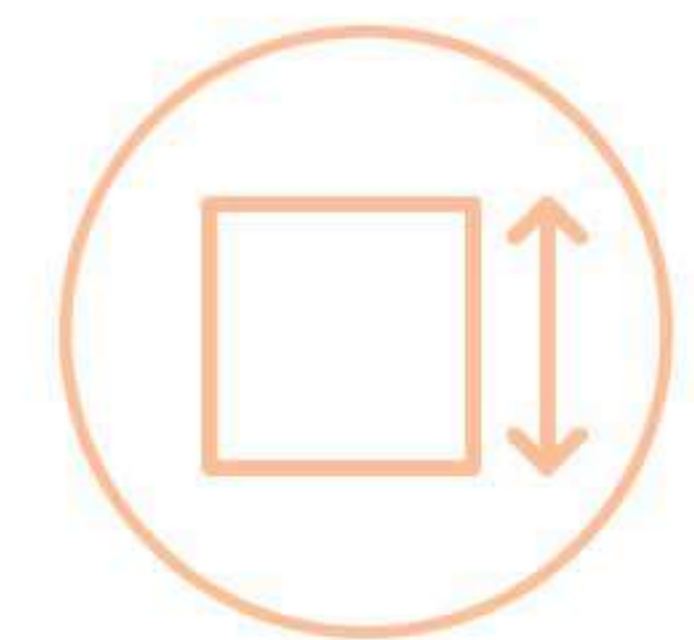

Height
Drawer Height
5" and above

CANISTER 100 GMS

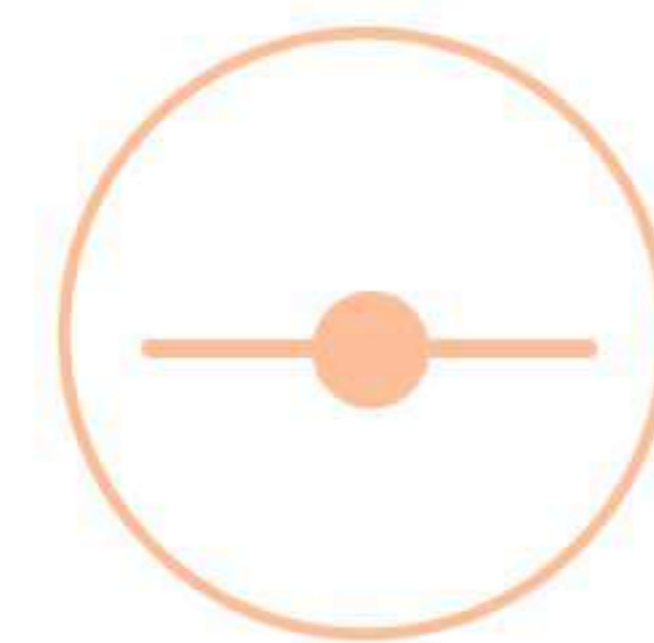

Price range



100 gms

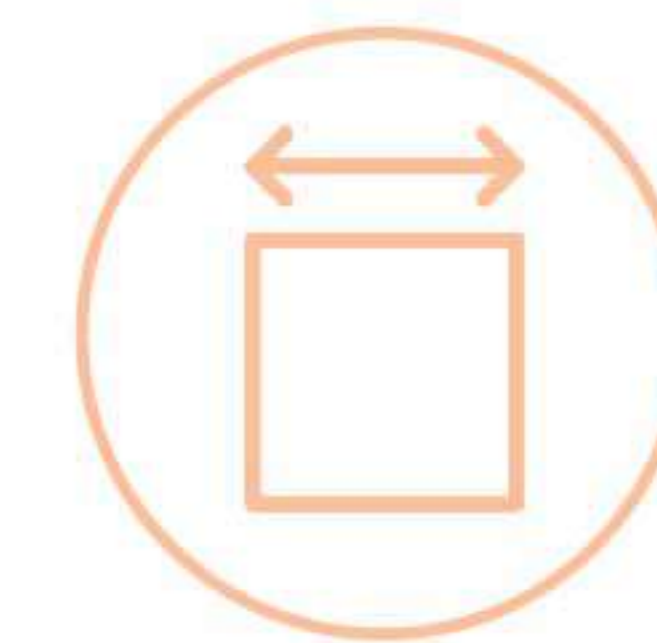

Width
450mm,
600mm

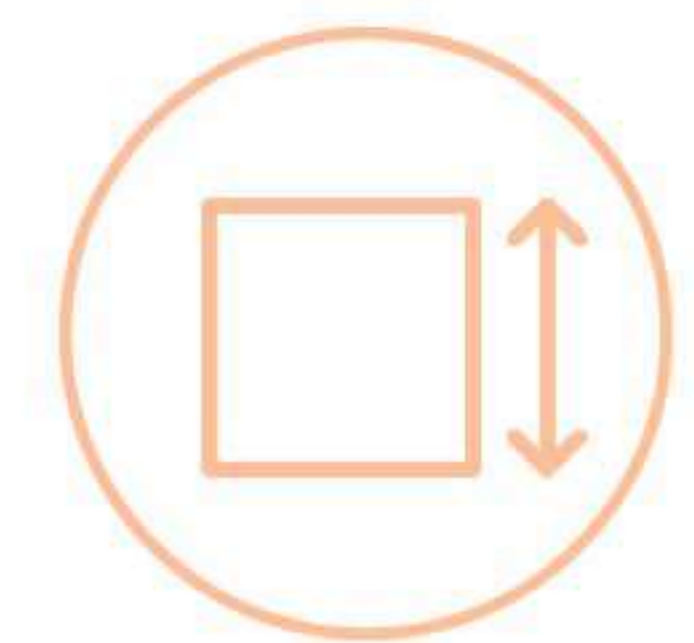

Height
Drawer Height
5" and above



GJ Enterprises

mail jai@gjenterprises.co.in
call +91 98410 68249
website www.gjenterprises.co.in
Address 153 Raju Nagar, First Cross
 Thoraipakkam, Chennai – 600 097

Follow us on instagram [@gj_designerhardware](https://www.instagram.com/gj_designerhardware)



GJ Enterprises

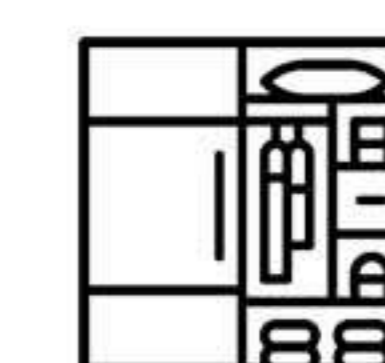

Wardrobe

Mechanisms and accessories

ABOUT US

GJ Enterprises was established in 2001 in a venture to facilitate as a one-stop-shop for the complete range of hardware for Kitchens, Wardrobes, Glass partitions, Locking solutions and other exclusive Interior Decorative accessories. The core idea was to persuade customers to add their own edge to their living and working spaces by using creative hardware accessories that we selectively import from some of the leading hardware manufacturers in Europe. In 2016, we launched our Experience Centre in OMR, Thoraipakkam, displaying our entire range of products. This step was taken with the intention and foresight of giving our customers a physical feel of the pristine quality of the products that we offer.

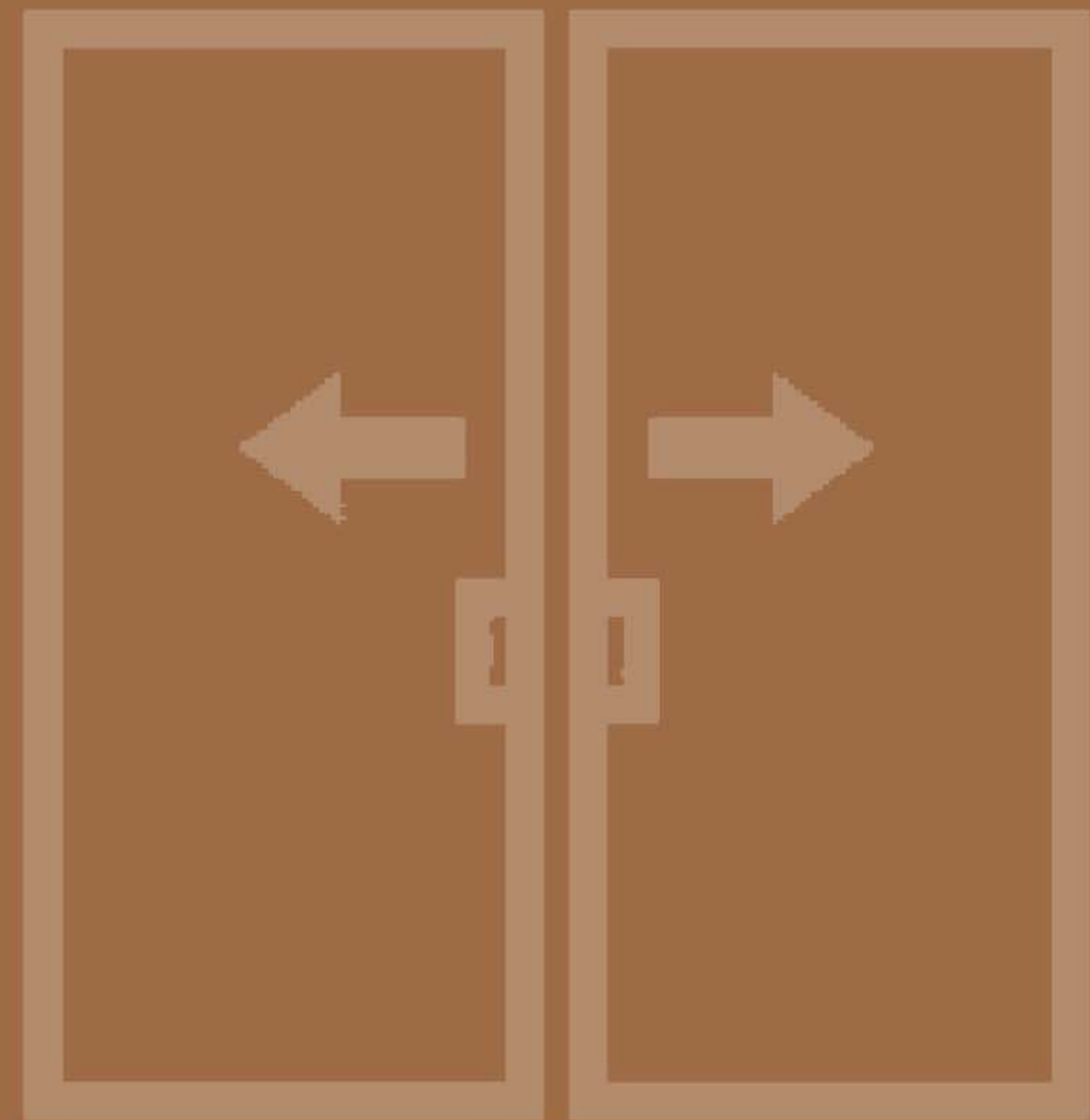

01 Sliding
Wardrobe
Mechanisms >>>

01

**Sliding Wardrobe
mechanisms**

17

**Openable Wardrobe
mechanisms**

27

**Wardrobe Organisers
Pullout**

51

**Wardrobe Organisers
Inserts**

57

**Wardrobe Lighting
profiles**

59

**Wardrobe Locking
systems**



CONTENTS

SLIDER L'70

COPLANAR SLIDING SYSTEM



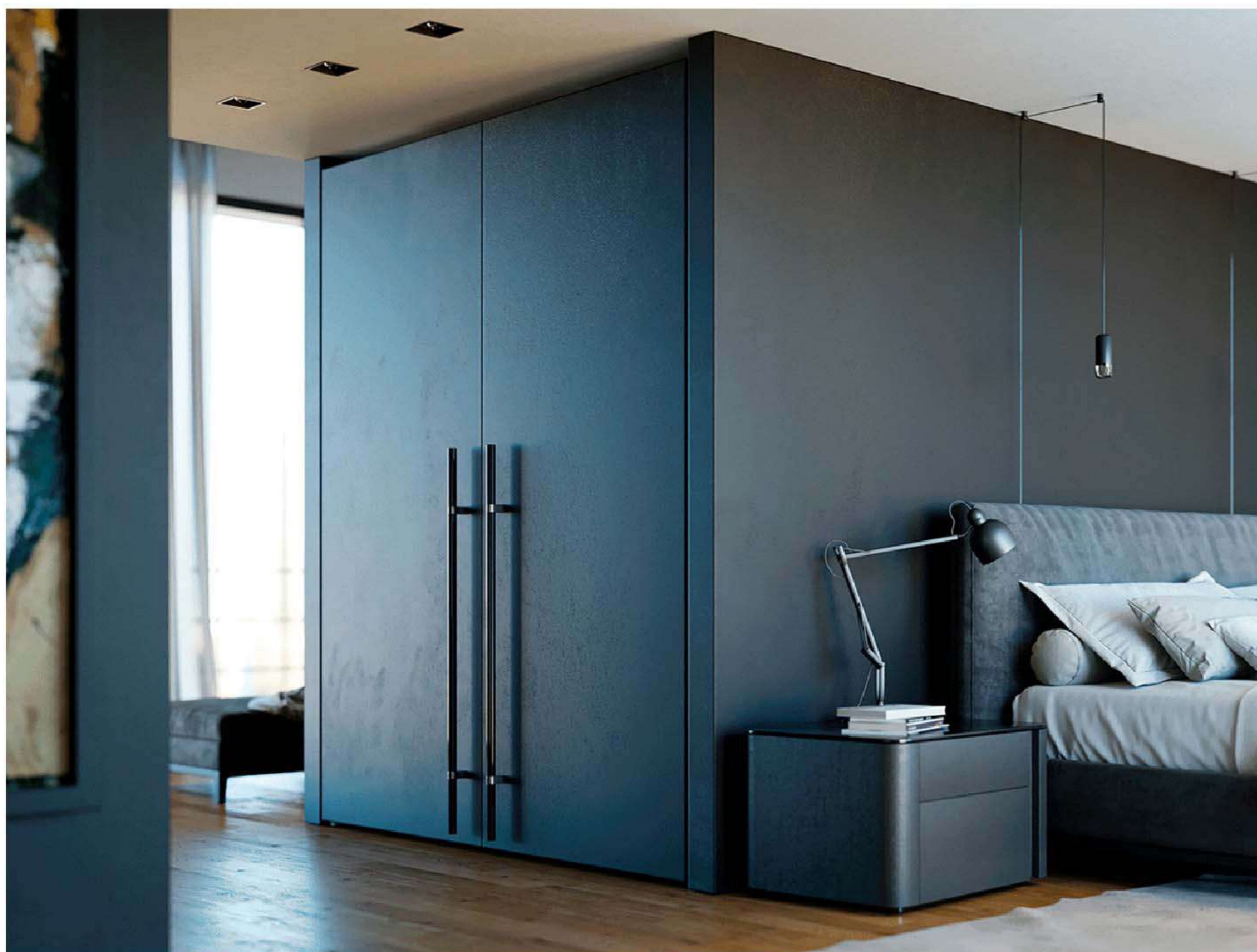

L70 is the coplanar system for cabinets with doors weighing up to 70 kg each. Thanks to the exclusive patented design of the slider range, the precision-built carriages and tracks and to the revolutionary linear magnetic damper, L70 delivers the smoothness and lightness of touch typical of Salice even with particularly heavy doors.

Available in two or three door variants, it can be specified with a customisable front cover. Its features of reliability, modularity and capacity make L70 ideal for wardrobes in the bedrooms & for all large cabinets in general.



SLIDER L 70

INLINE SYSTEM

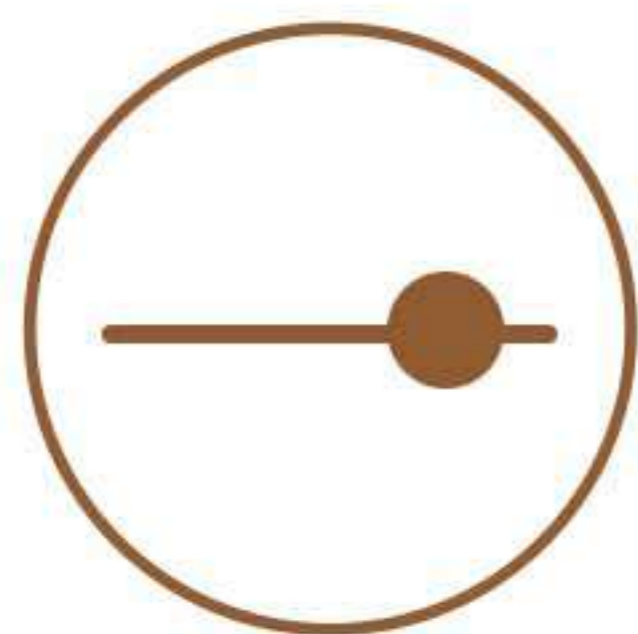

Price range



70/100 Kgs



Door Thickness
18mm & 45mm
with handle

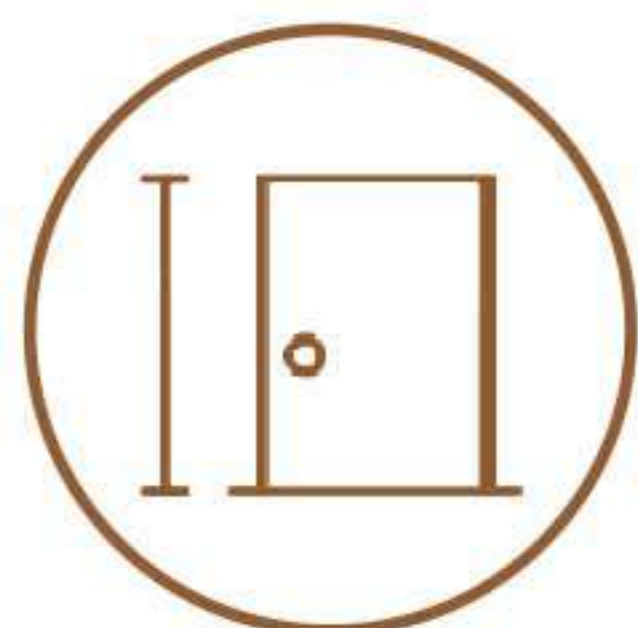

Height
Upto 3000mm

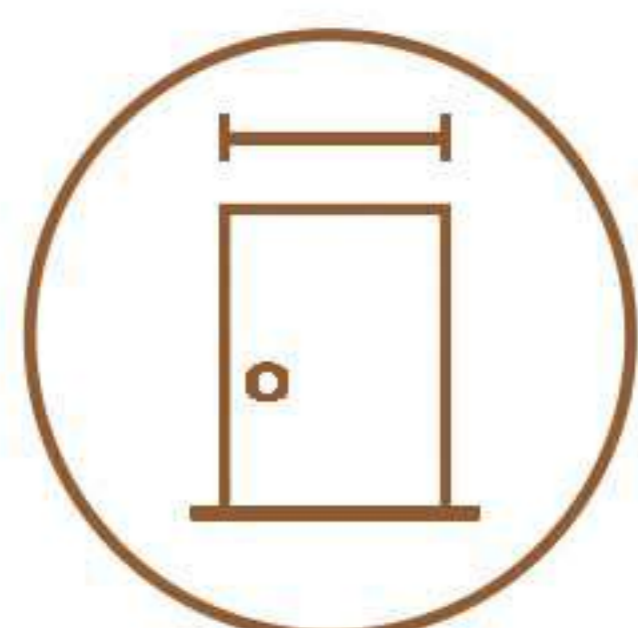

Width
800-1200
per shutter







STRIKE + OVERLAPPING SYSTEM





Strike+, a sliding system for wardrobes with 2,3 or more overlapping doors, is now equipped with a revolutionary magnetic damping system that decelerates the opening and closing action and delivers an extremely fluent and silent movement.

This innovative solution sets a new standard of silent and smooth sliding movement by eliminating the typical noise and resistance produces by spring-action dampers and enables the door to be easily opened.



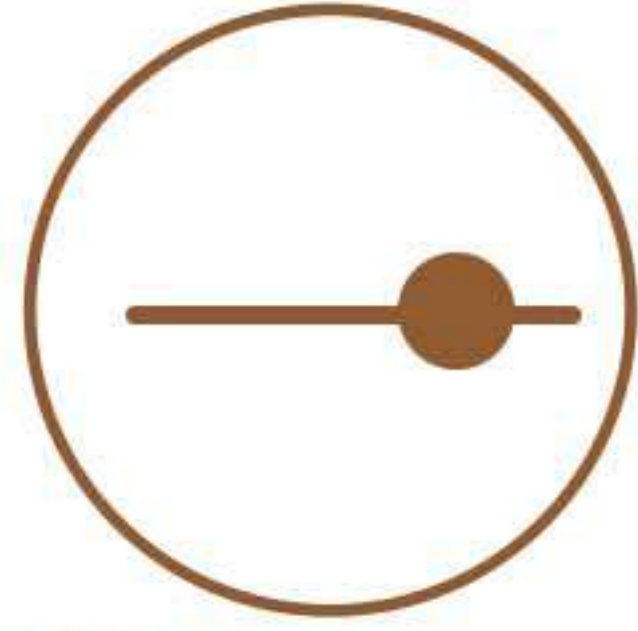

Price range



70/100 Kgs



Door Thickness
23, 30,35,
40,mm

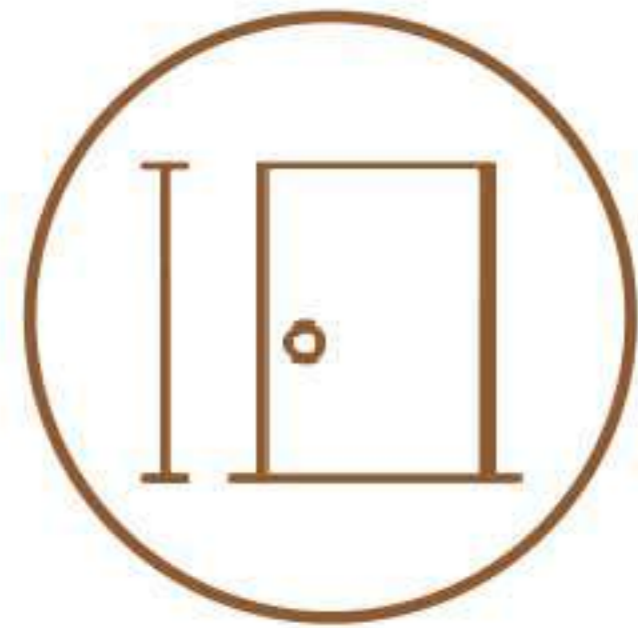

Height
Upto 3000mm



Width
2 doors- 600 mm
3 doors- 830mm



FT2A

SLIDING & FOLDING SYSTEM





FT2A with its bifold folding mechanism, Effortlessly blends Ergonomics with Space optimization. With its provision to work as a hinged as well as a freely moving mechanism, FT2A is the perfect choice for smaller spaces looking to replace openable shutter facades with something more lucrative.

Best coupled in pairs of doors moving to the right and left, the FT2A helps open out the wardrobe space a 100%,affording a clear, uninterrupted vision of the storage cavity within.

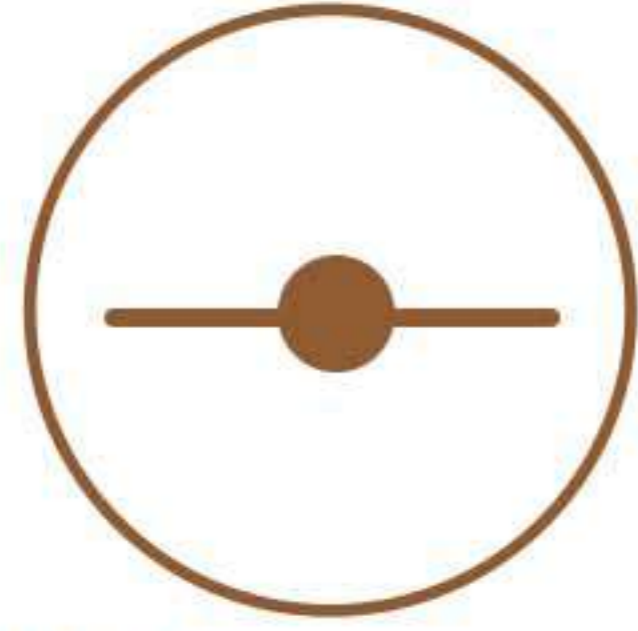

Price range



35 Kgs per leaf



Door Thickness
18- 26mm

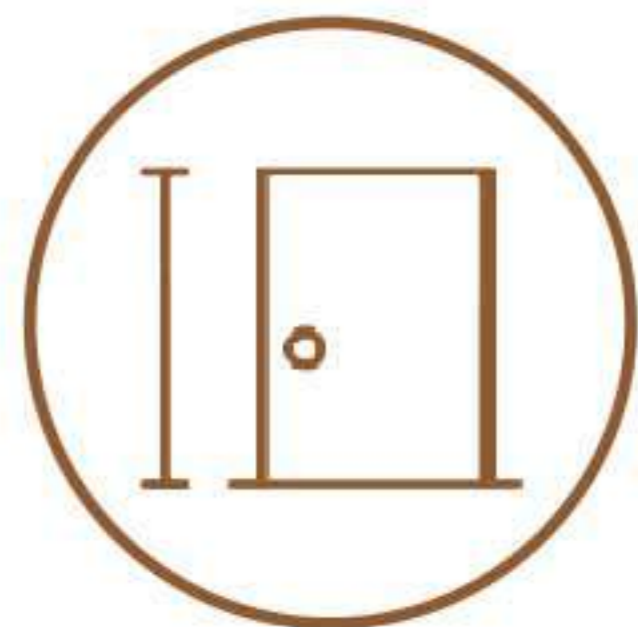

Height
Upto 2700mm

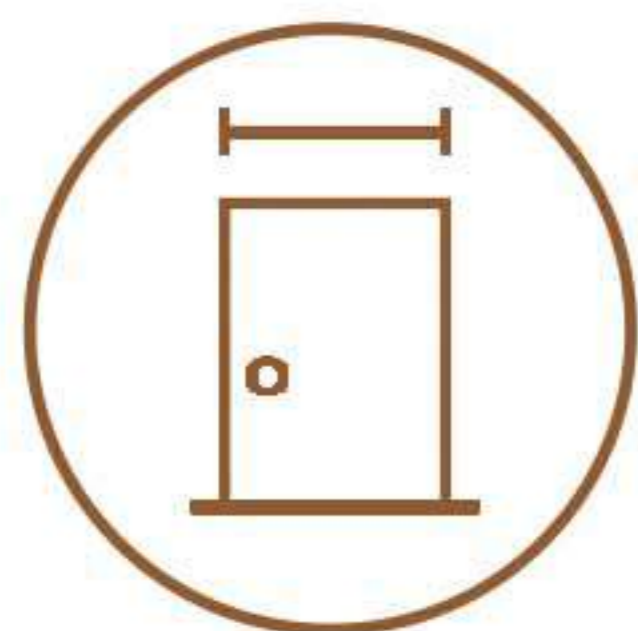

Width
500 mm per leaf



FLY

PROFILE SLIDING WARDROBE



FLY is a versatile, design-forward wardrobe mechanism that lends itself to a plethora of customisations;
A blend of contemporary linearity and gliding elegance, FLY enables full length, floor to ceiling wardrobes, that imbues Silent largesse and subdued grandeur to any lived-in space.

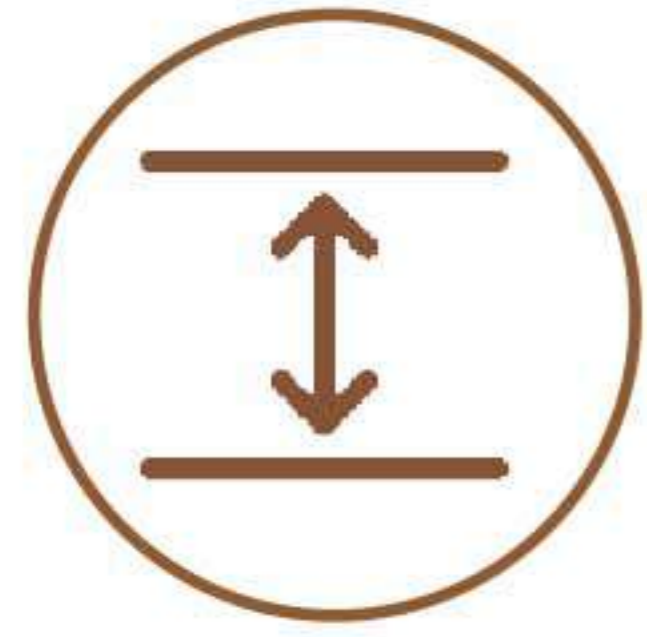

Floor to ceiling



Sliding doors with locks

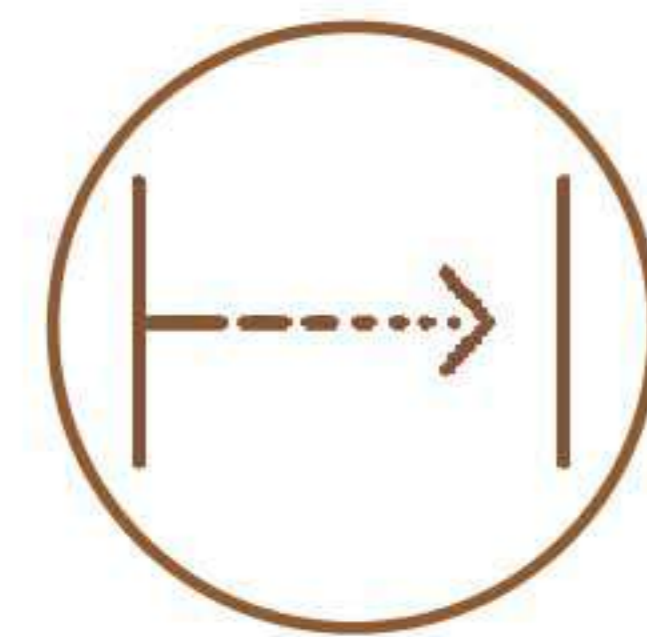

Soft closing doors



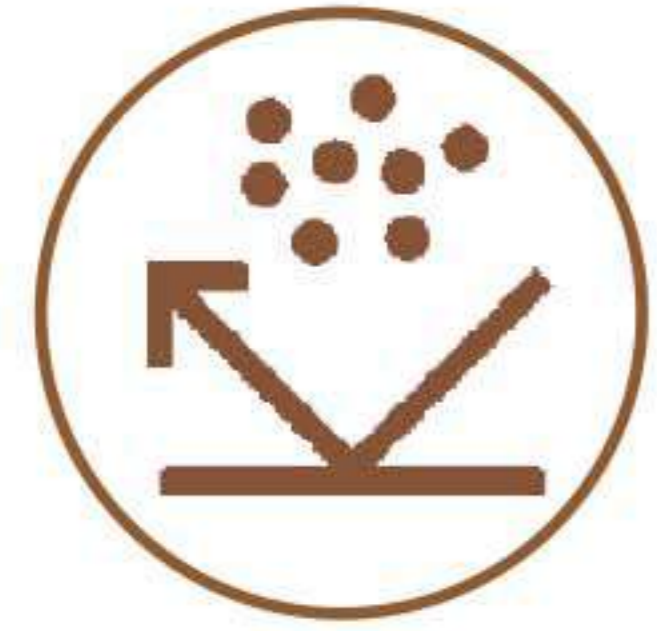

Dust protection buffer strips

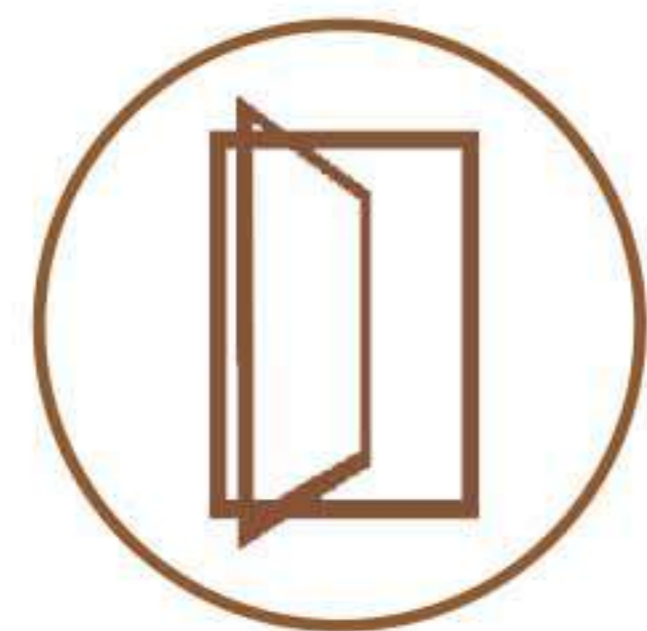

Pivot doors

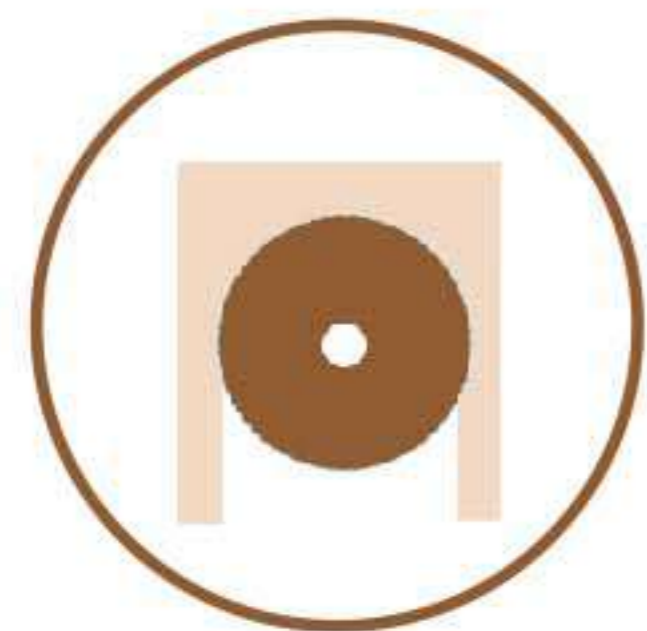

Anti Jump Rollers



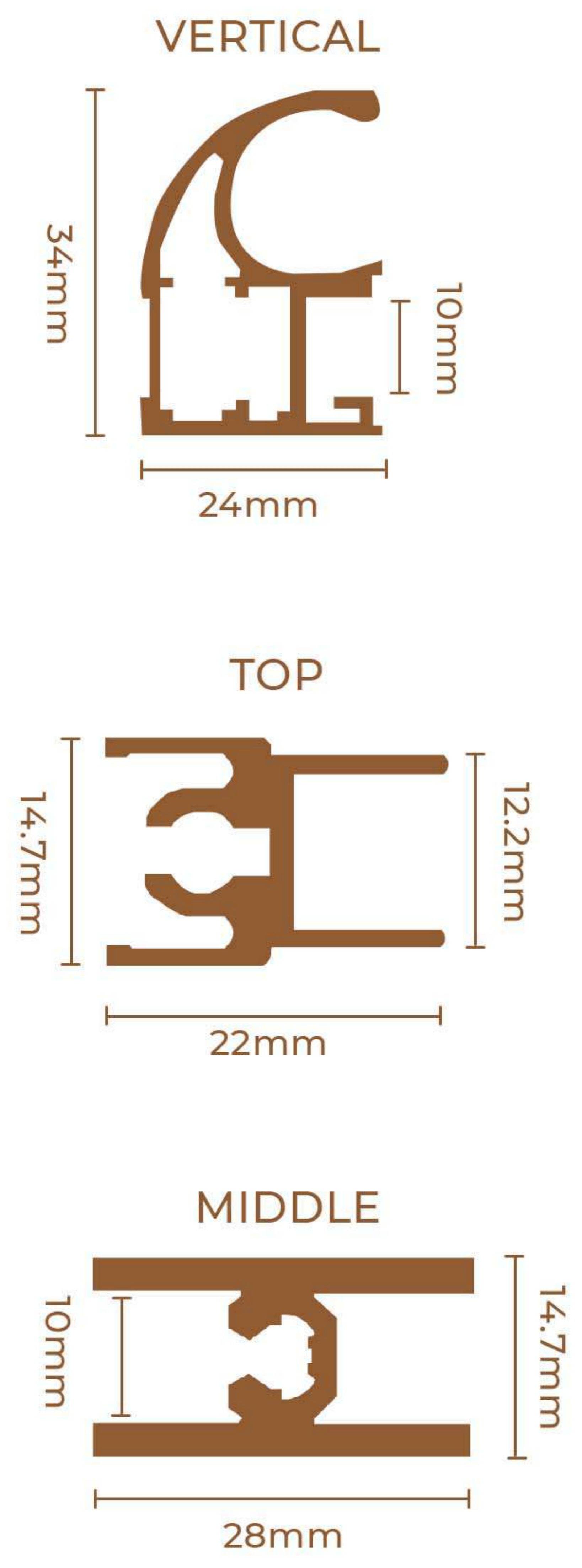

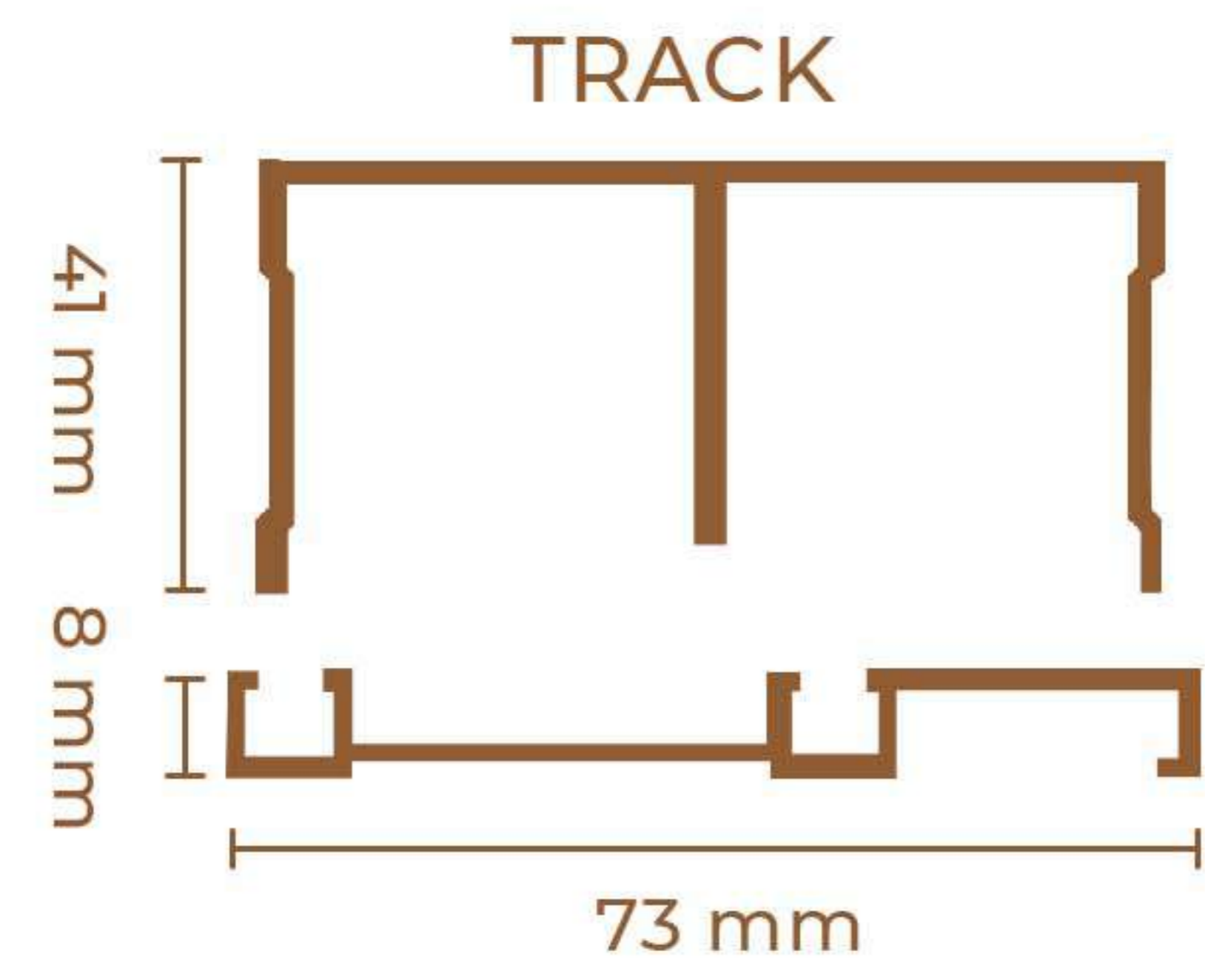
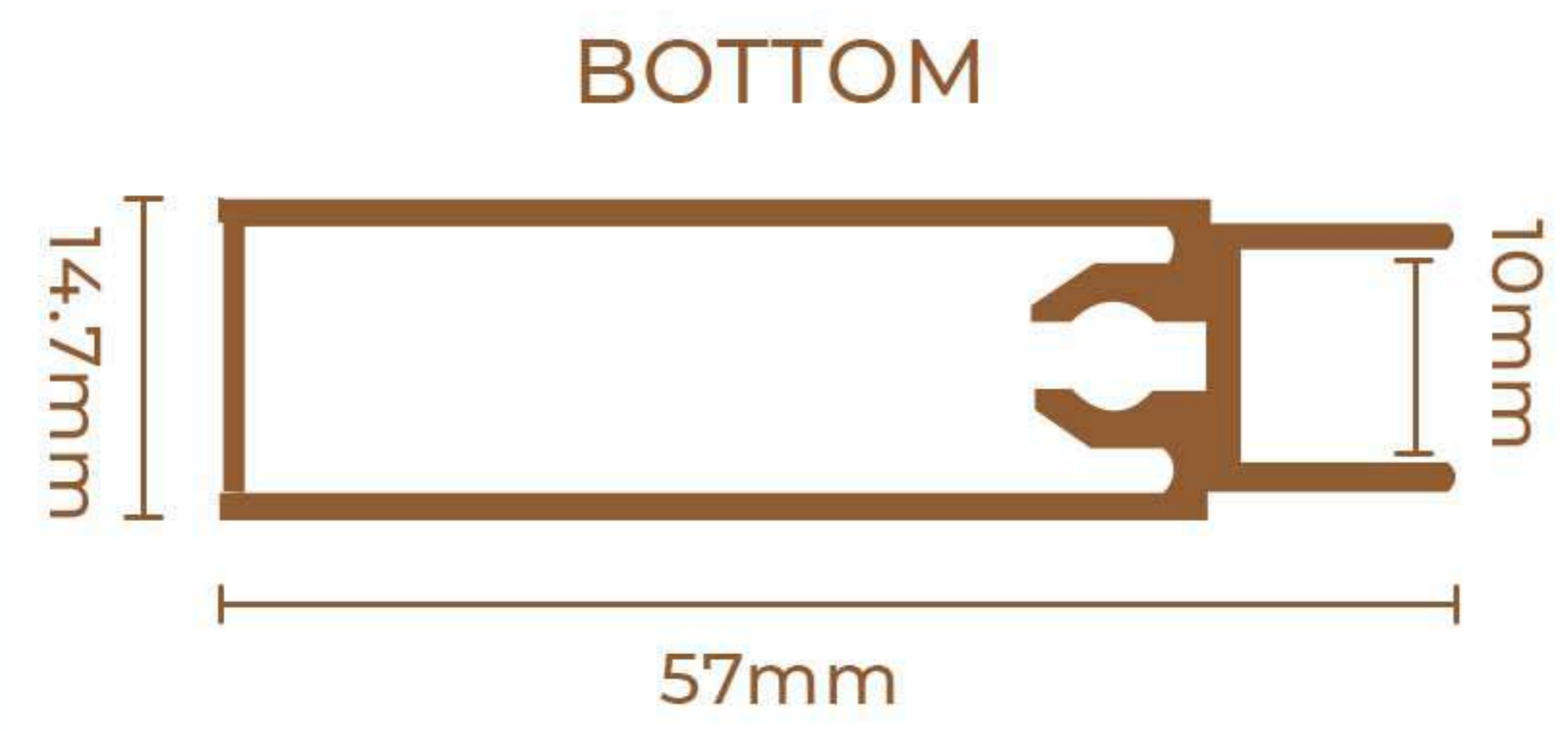

01

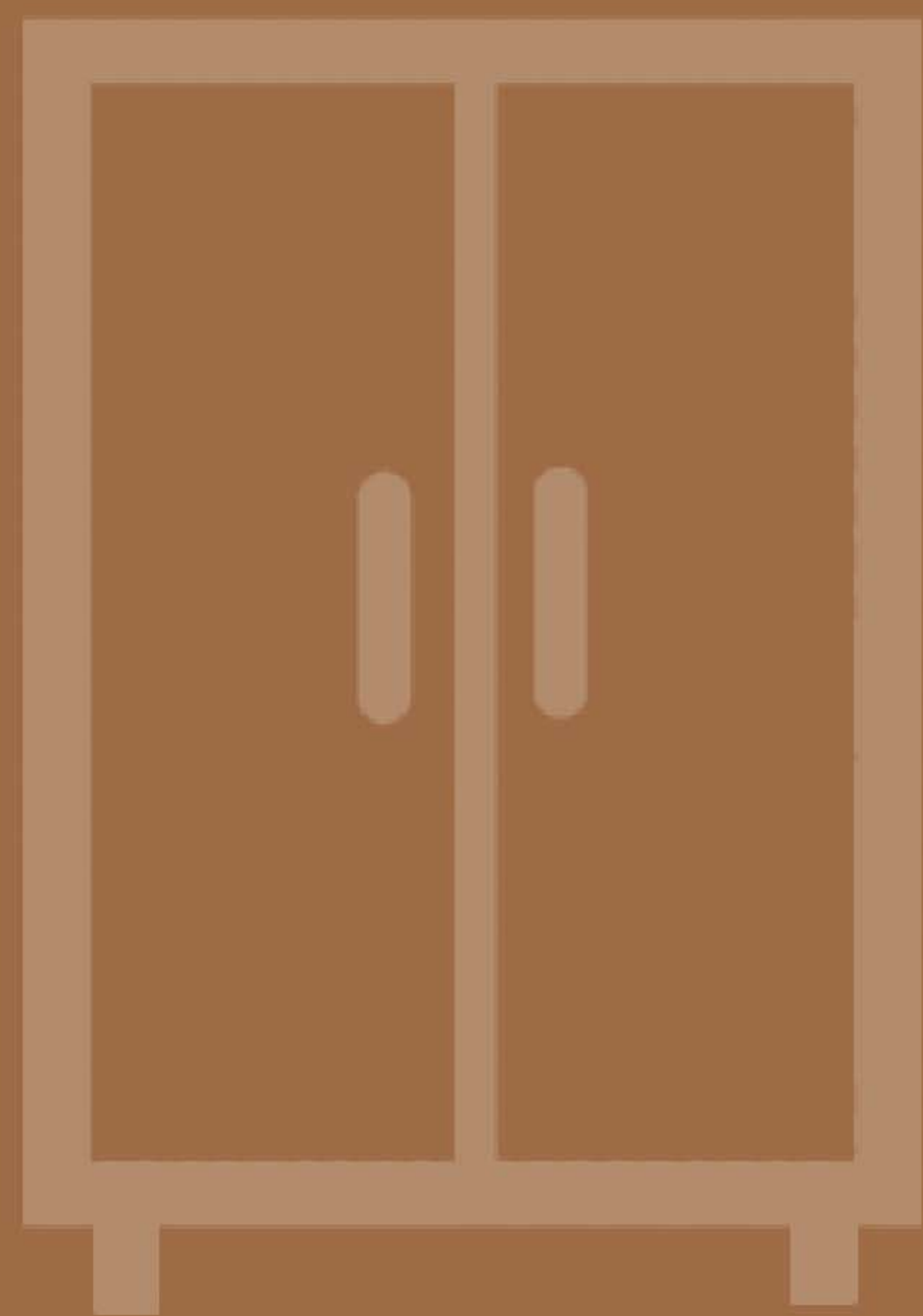

02 **Openable
Wardrobe
Mechanisms** >>>

03

BLACK MATT SERIES

PROFILE SILHOUTTES

Contemporary Minimalism gains new definition with these singularly striking frames. These framed shutter mechanisms, custom-fabricated to size lend definition to your cabinetry while retaining the broad cleanliness and silence of well-crafted spaces.

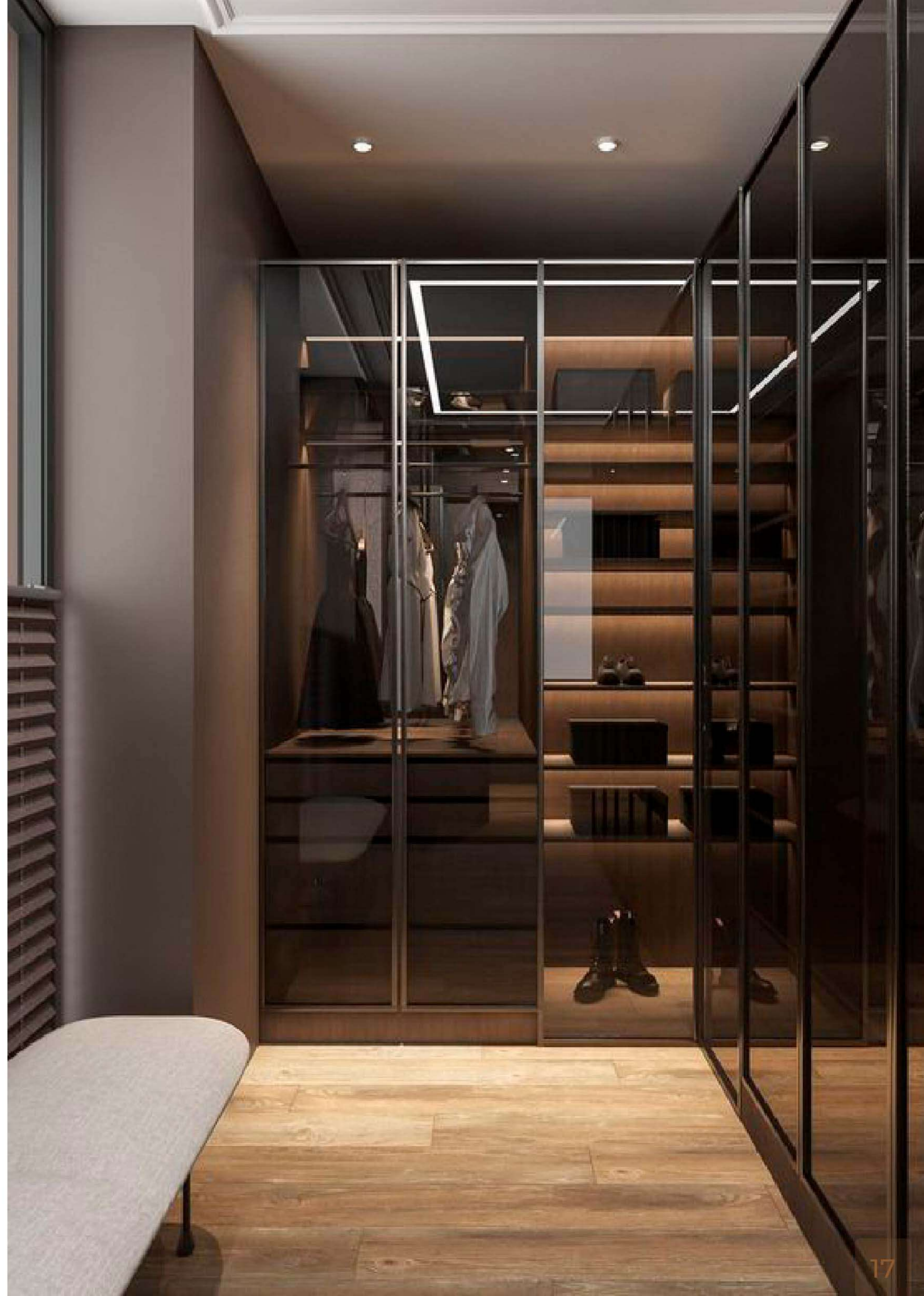



A study in Contemporary Minimalist Linearity..

VARIANT 1

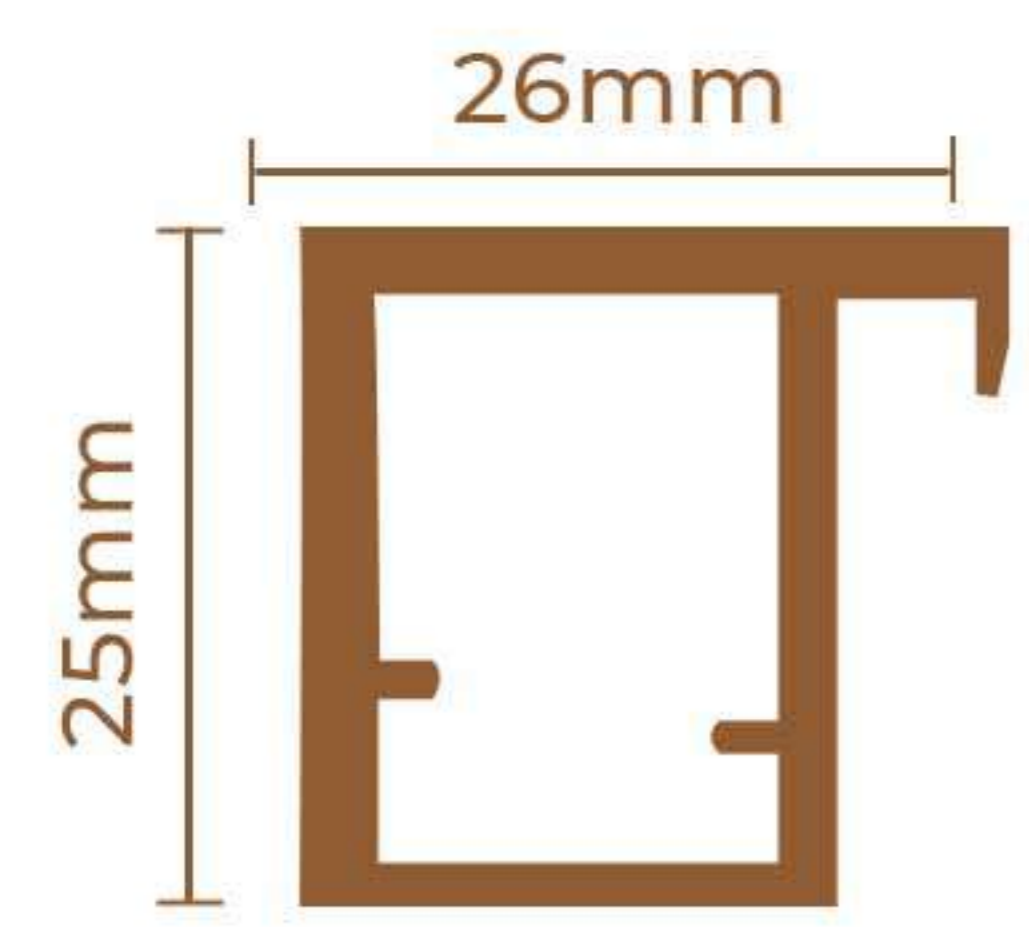

VARIANT 2

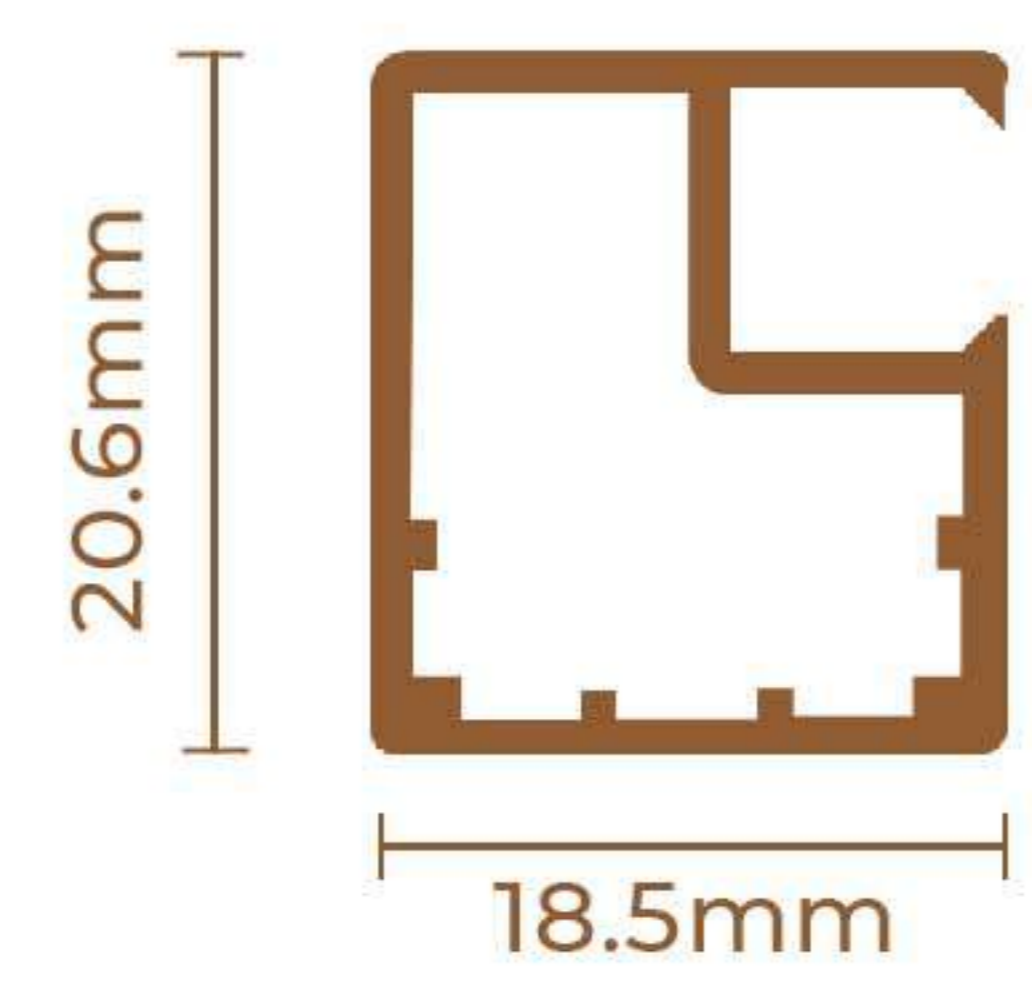
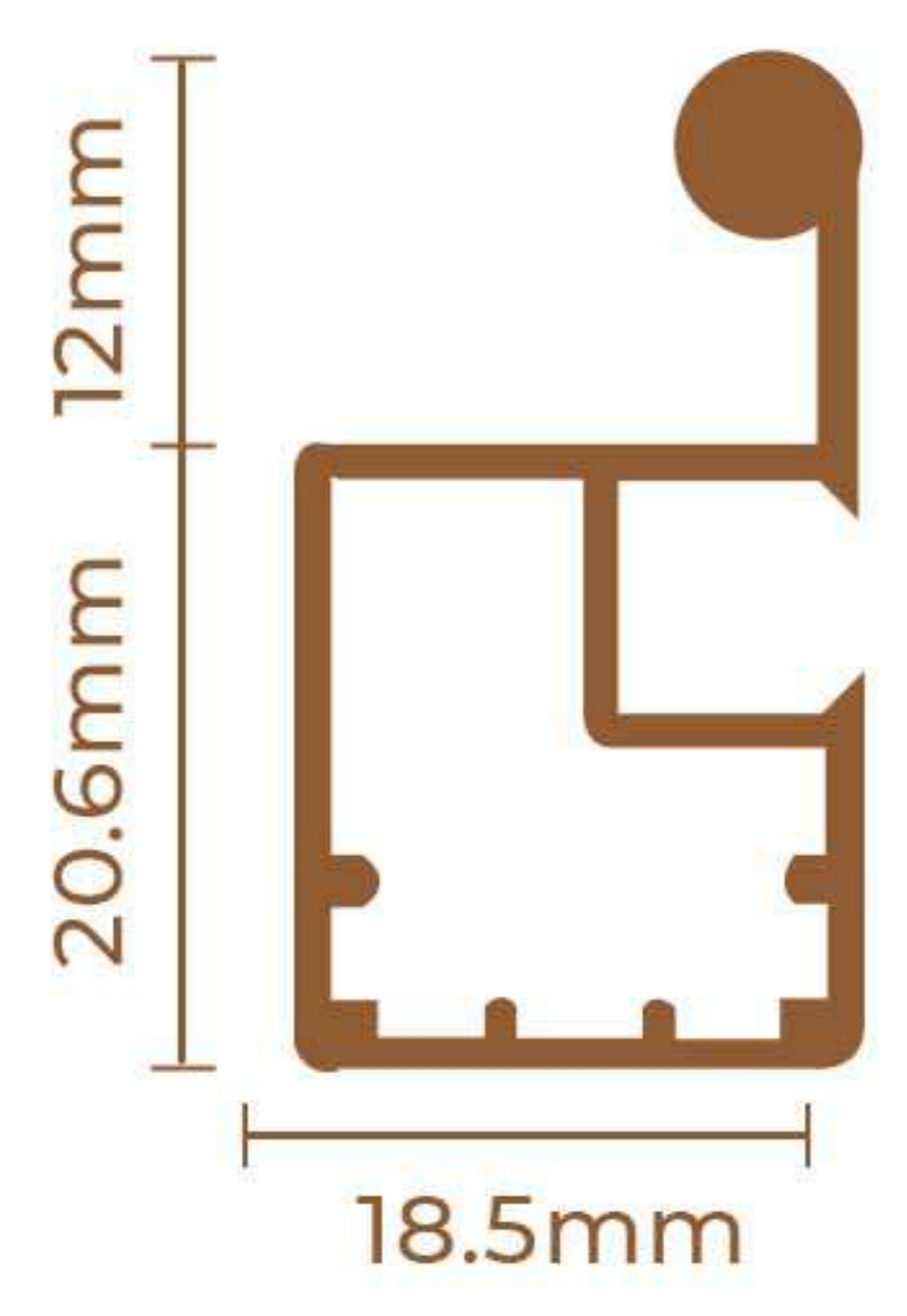
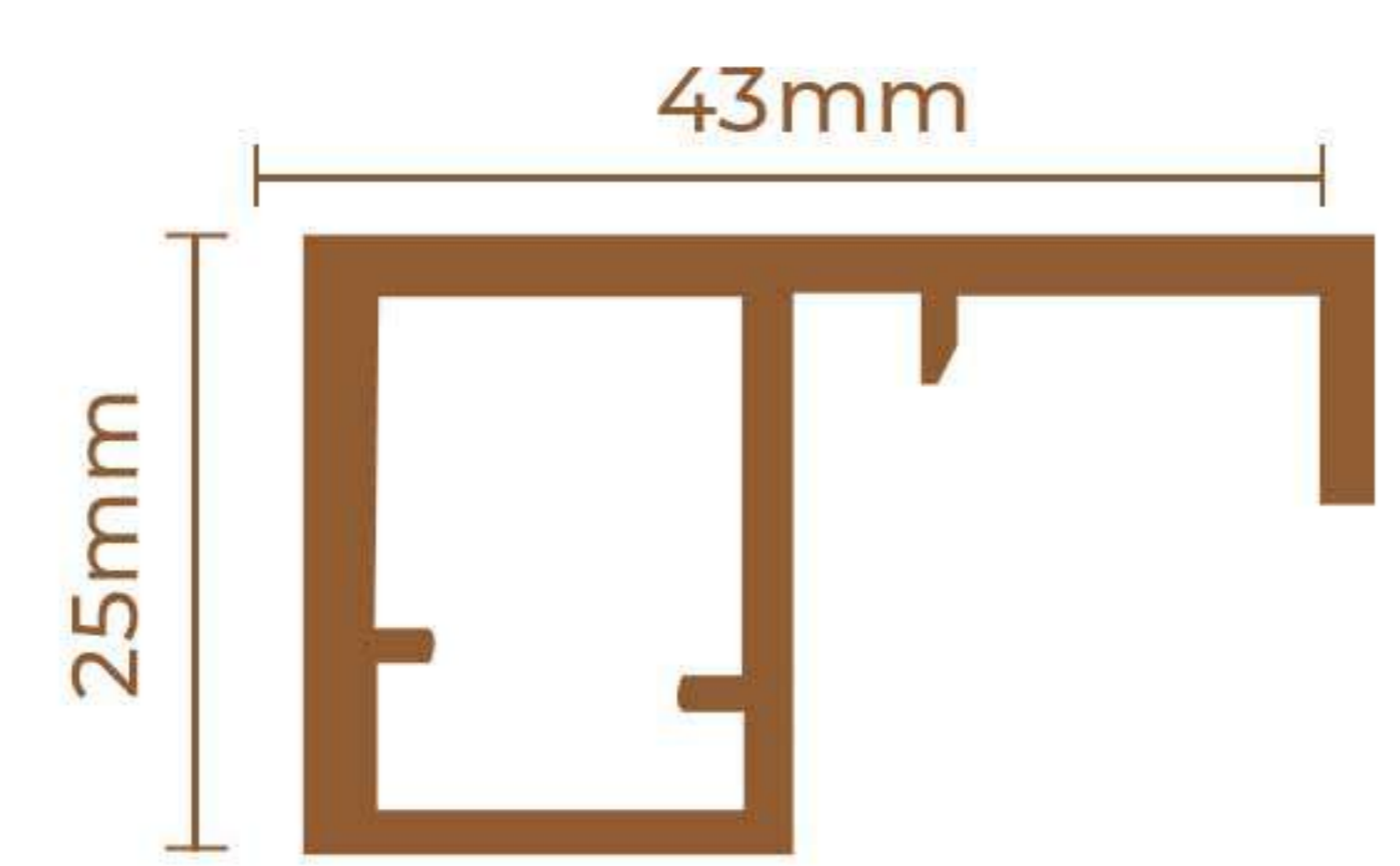



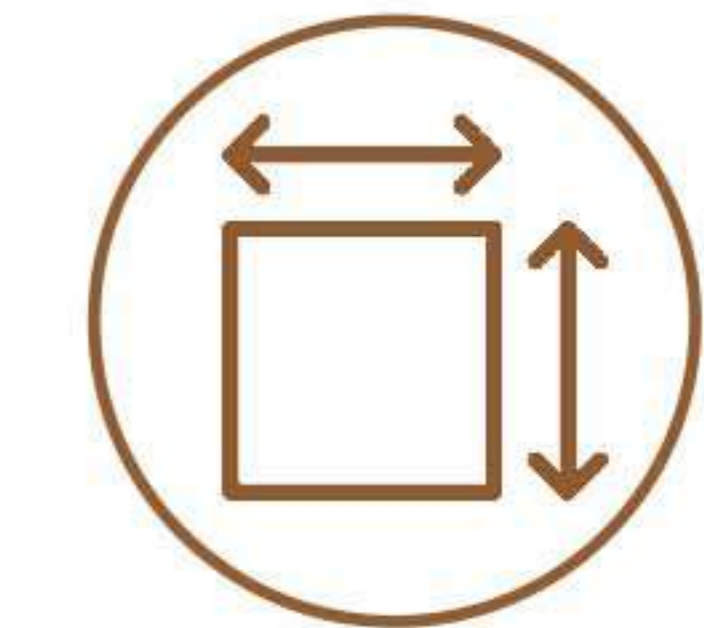

W X D X H
2850mm Max
Width:600mm per leaf

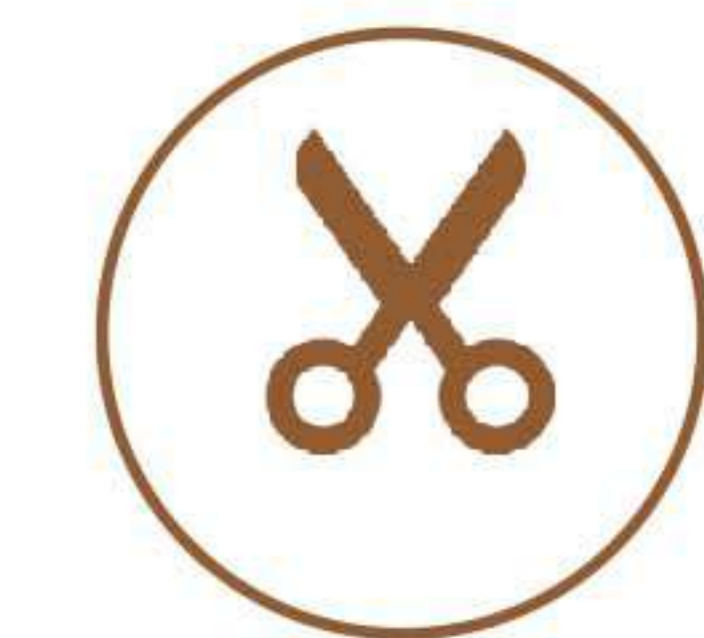

**Custom fabricated
to size**

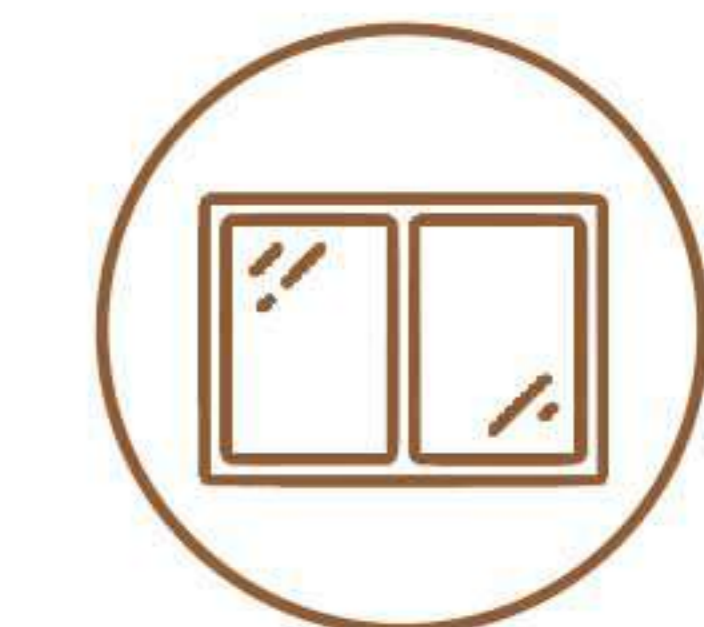

**Custom Insert Options -
Tinted/ Clear Glass**

BRUSHED GOLD SERIES

PROFILE SILHOUTTES

Brushed, burnished and brilliant, the all new series of profile shutter facades in hairline brushed Gold finish is opulence underlined with stately decadence.

Walking into a space, the definition and understated grandeur of combining these frames with tinted glass inserts elevates and brings forth the lifetsyle in luxury.





VARIANT 1

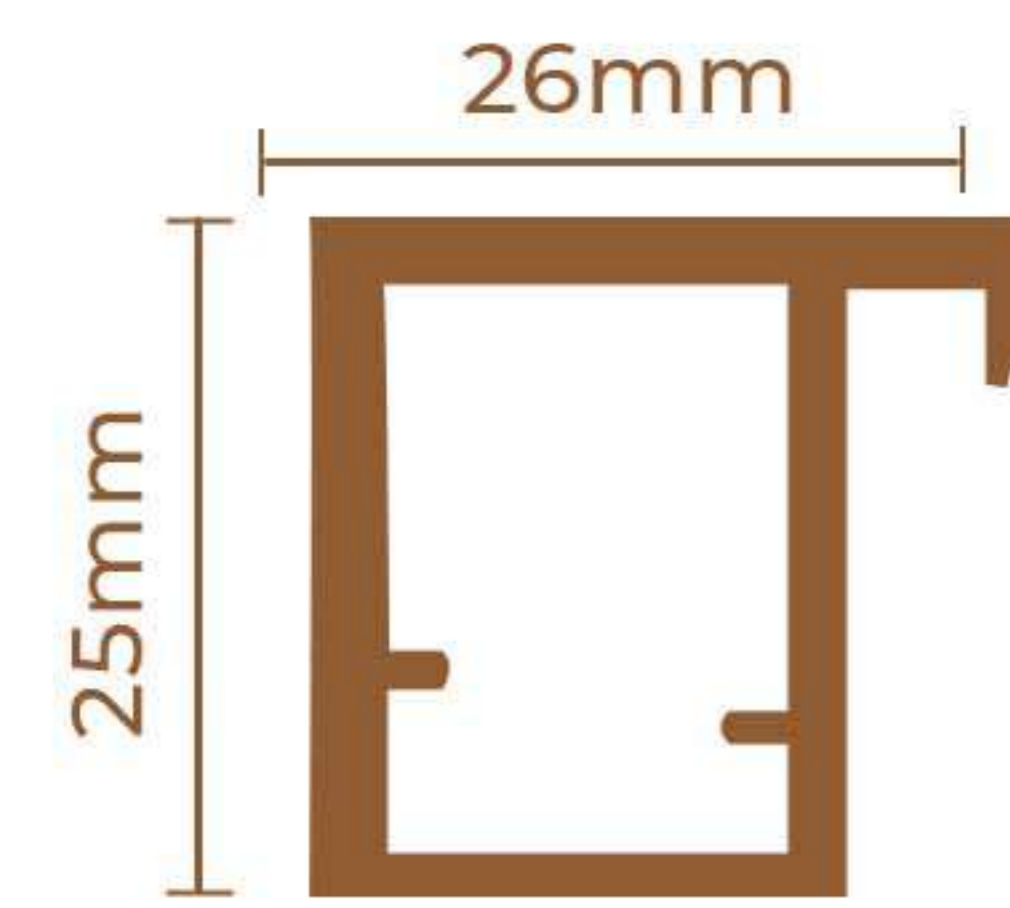

VARIANT 2

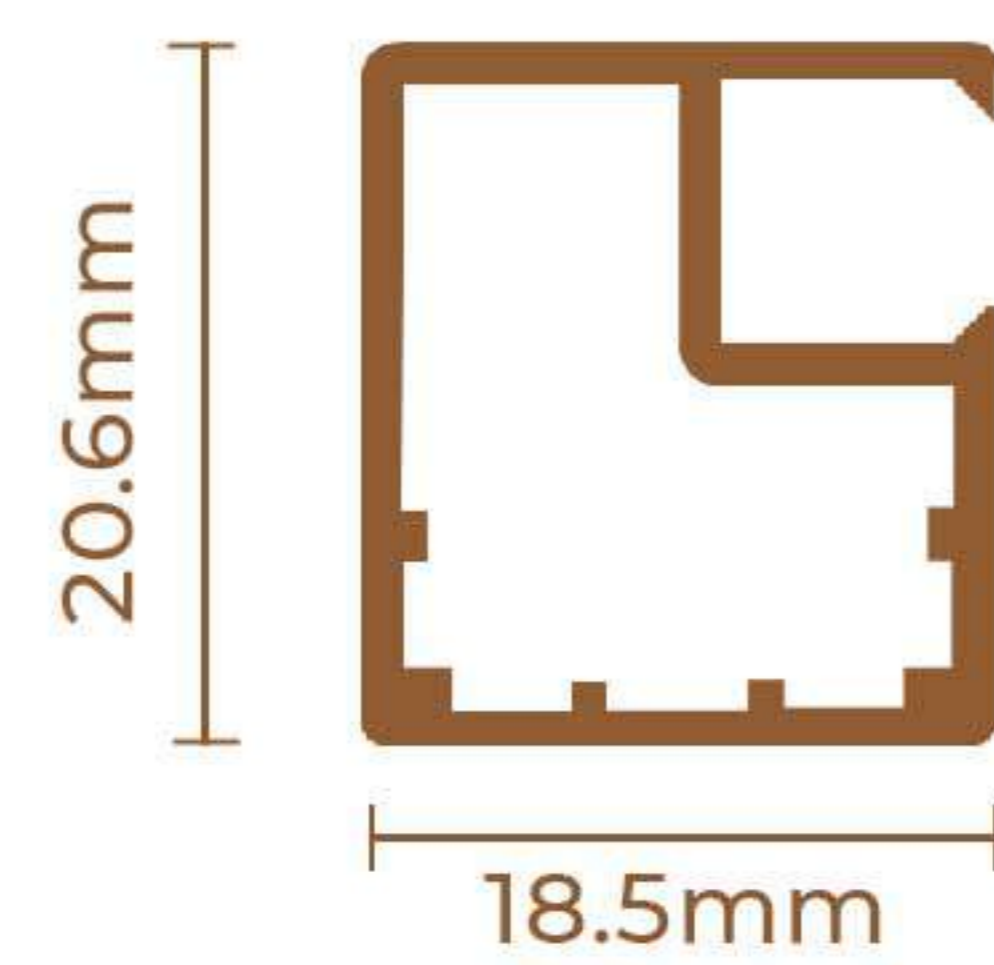
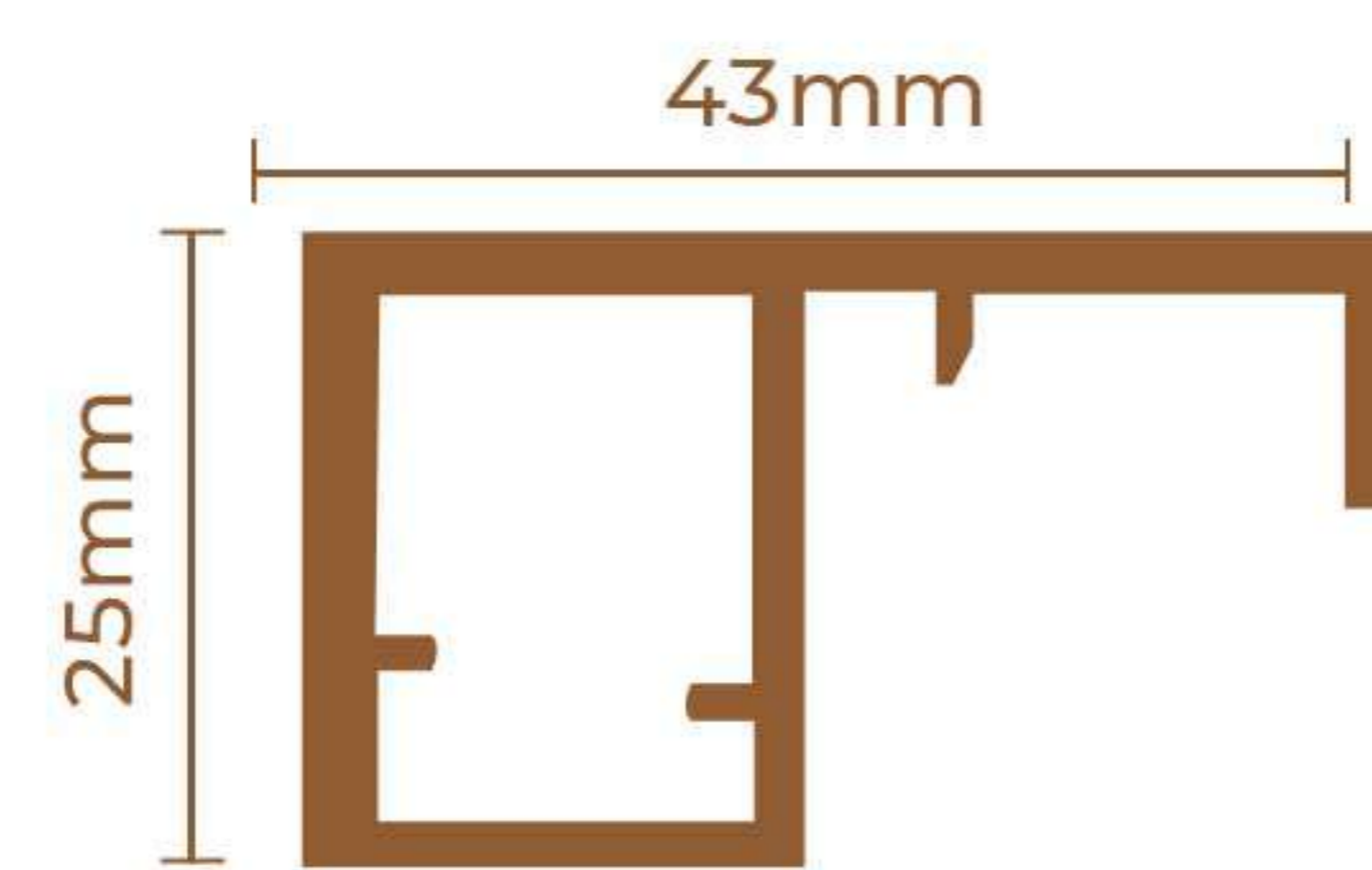

BRONZO

PROFILE SILHOUTTES

This innovative solution sets a new standard of silent and smooth sliding movement by eliminating the typical noise and resistance produces by spring-action dampers and enables the door to be easily opened.

This innovative solution sets a new standard of silent and smooth sliding movement by eliminating the typical noise and resistance produces by spring-action dampers and enables the door to be easily opened.



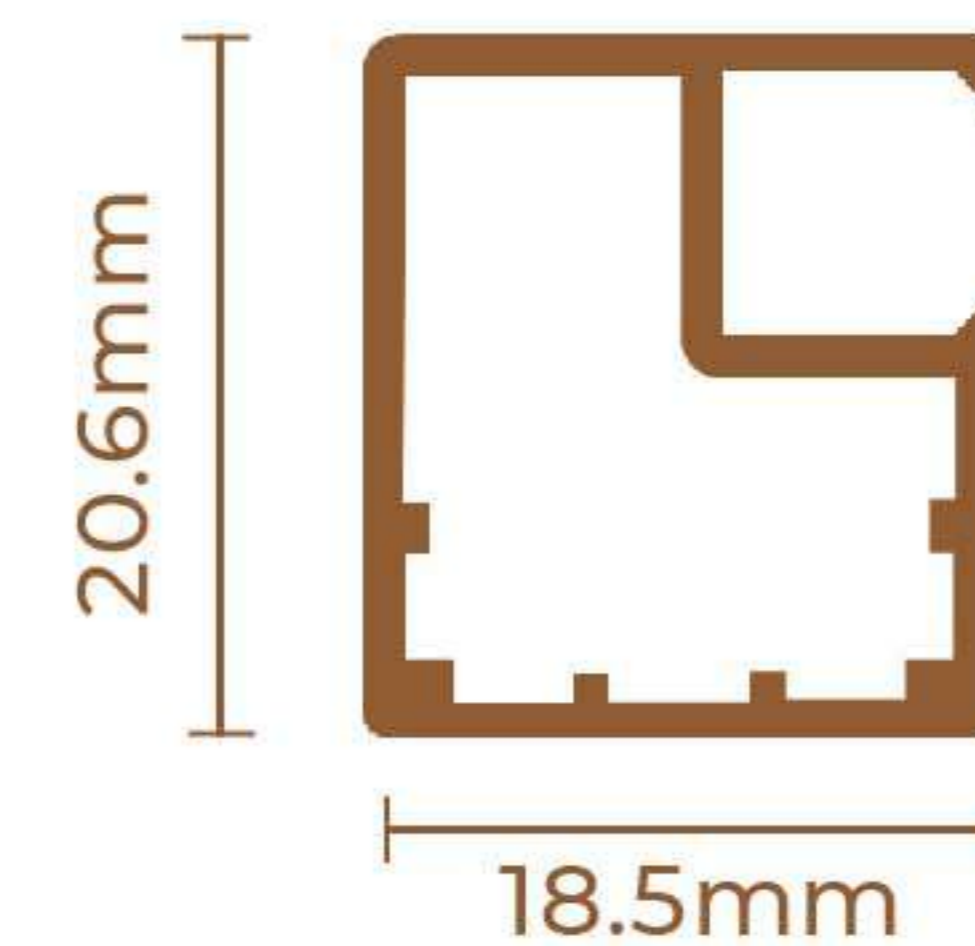
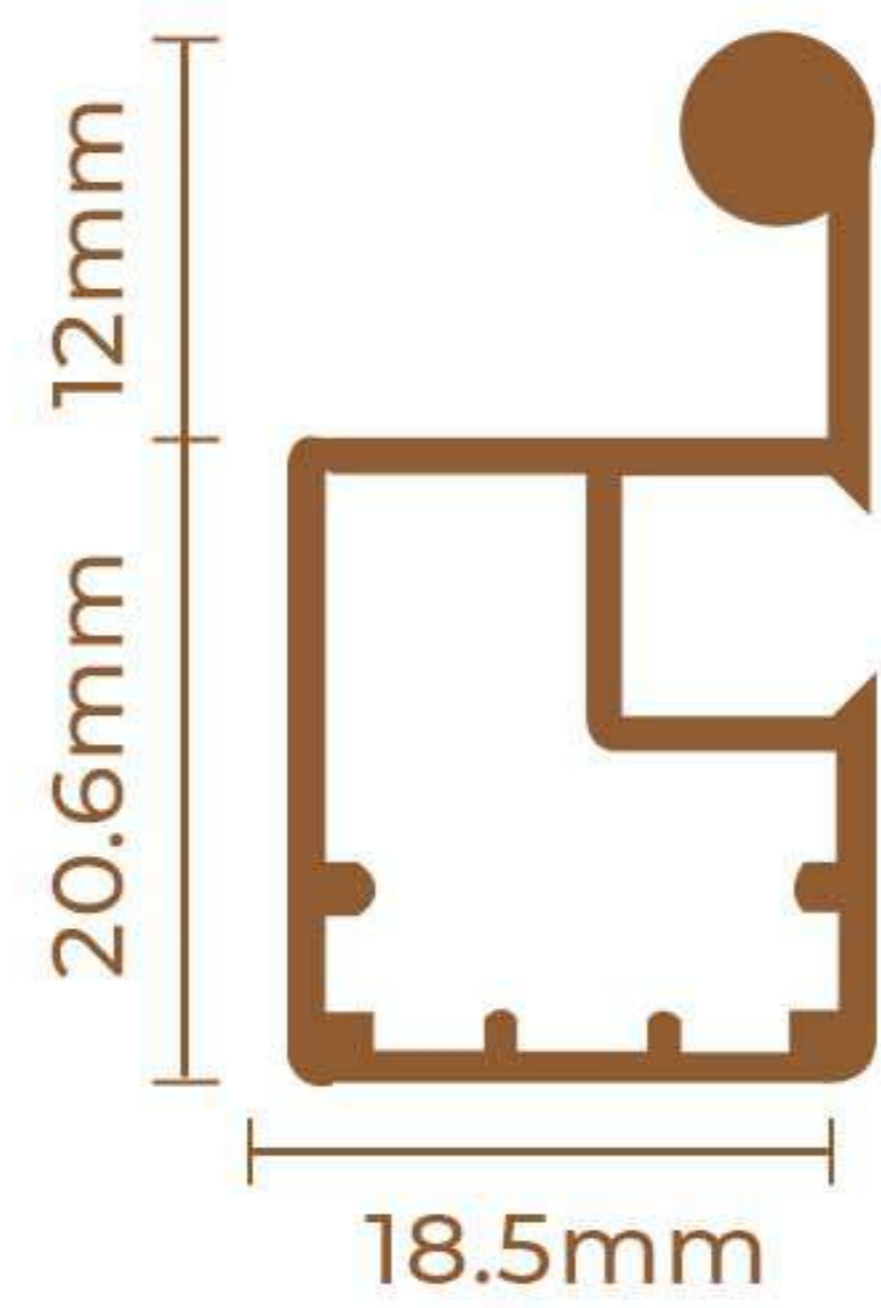
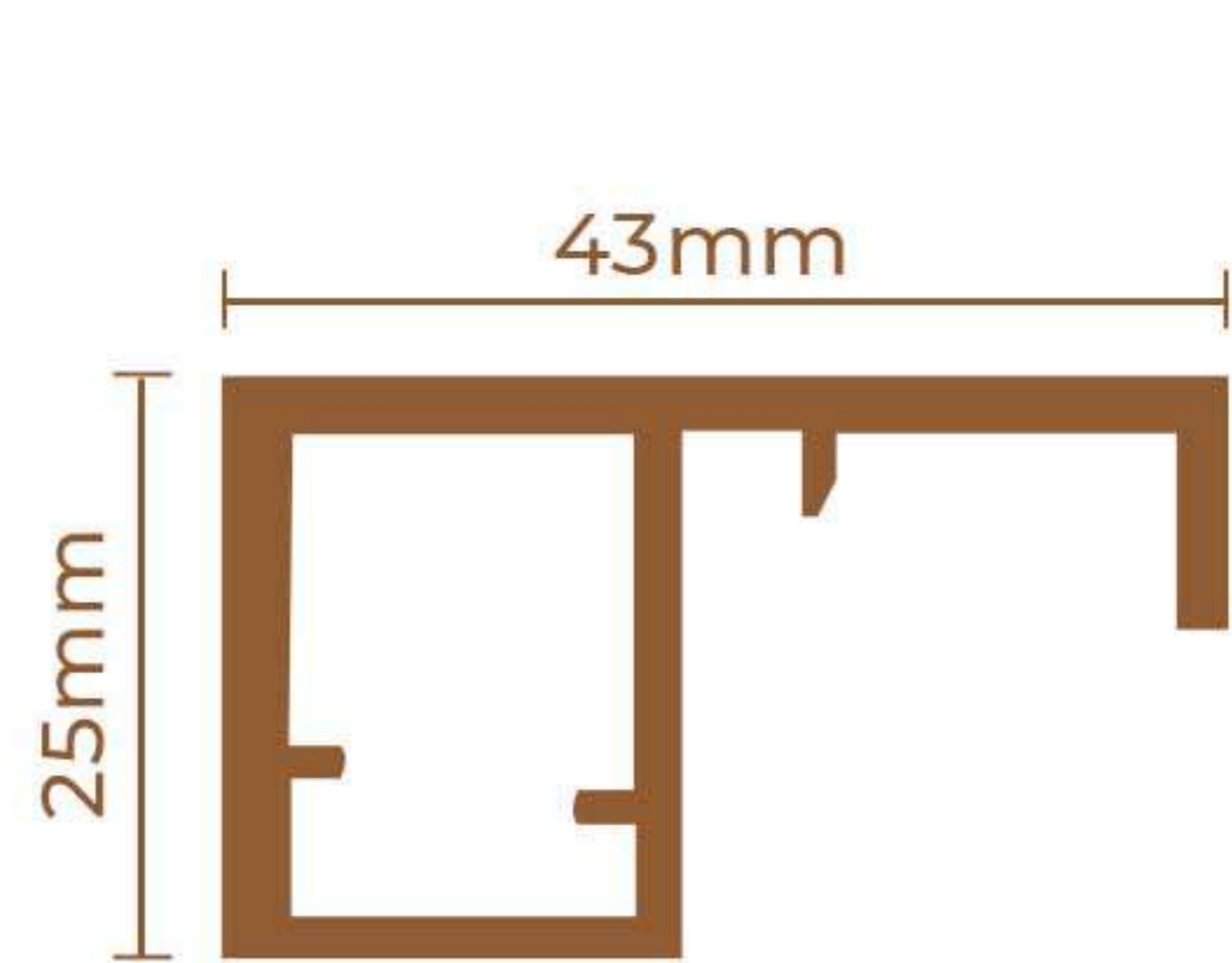
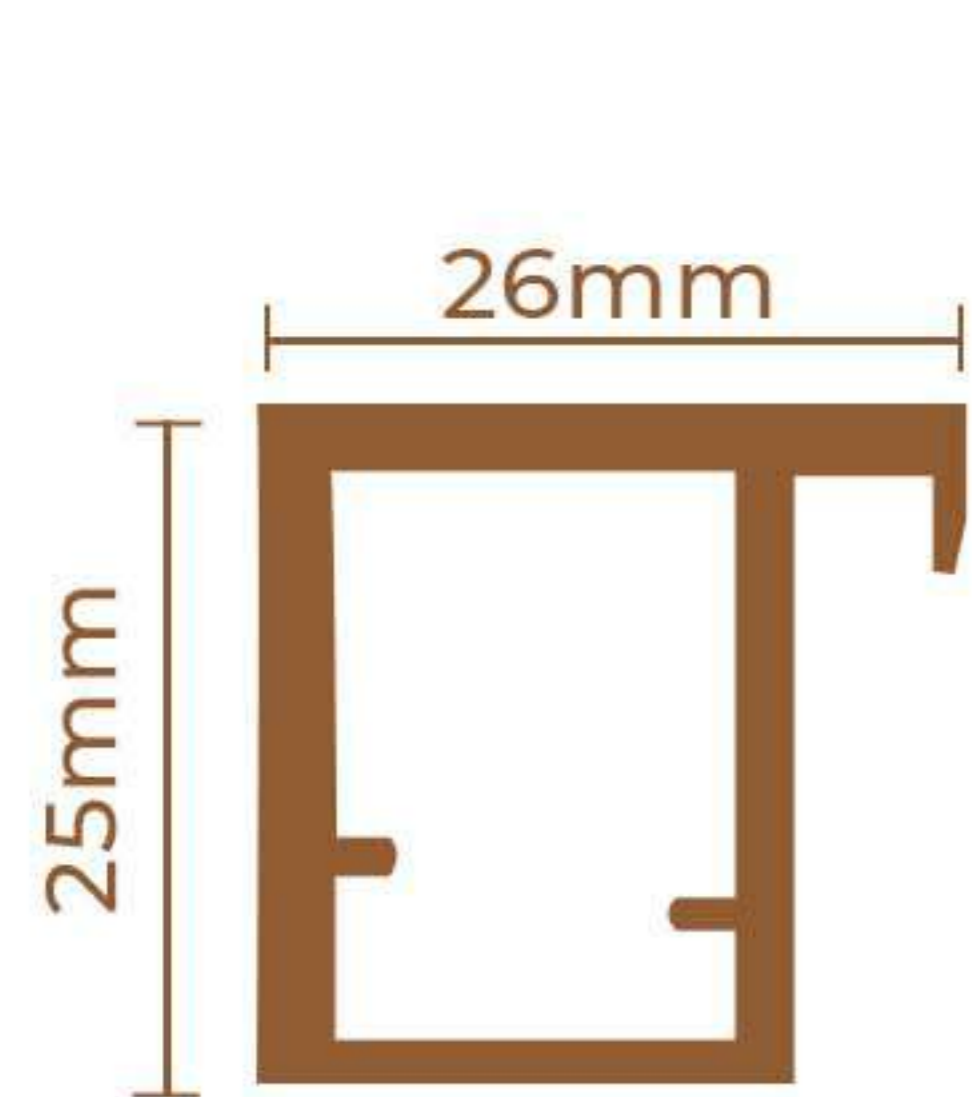

02



03 Wardrobe
Organiser
Pullouts



04

An **organized closet** is undeniably the way to an organized lifestyle. And to achieve that, you need accessories that can help you look beyond the clutter of everyday.

Our Vegan leather pullout organizers not only imbue style and sophistication, But open up the possibility of a **dynamic wardrobe space** that lends itself to your evolving demands as you get ready to conquer the day.





ACCESSORY PULLOUT

- Plush Vegan Leather Interior
- Spacious, Linear Compartments
- Perfect Accessory for Jewellery, Watches and other accessories

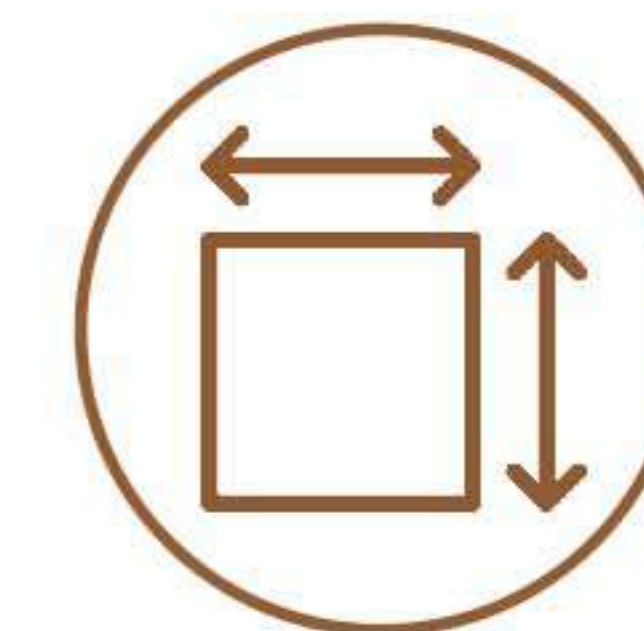

W X D X H
564 x 469 x 85
864 x 469 x 85



Vegan
Leather



Jewellery/
Cosmetics/Fine
Wear

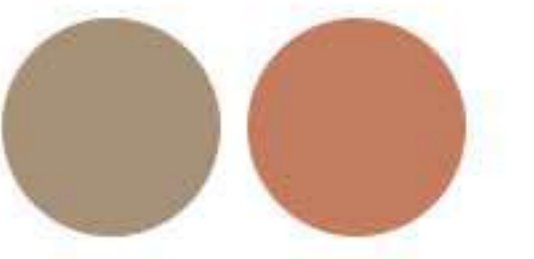

BASKET PULLOUT



- Spacious & Easy Extender Accessory
- Affords a complete view of the Interiors
- Perfect accompaniment to storing clothes, Linens and more

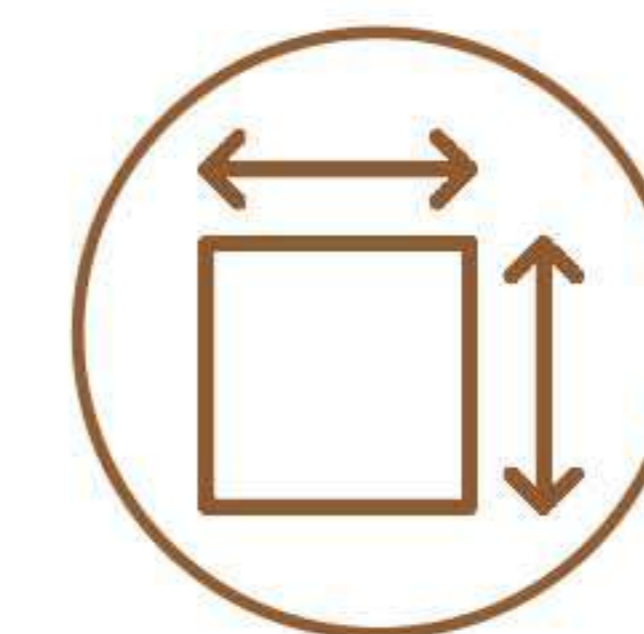

W X D X H
564 x 469 x 169
864 x 469 x 85



Vegan



Apparel
Storage



MESH PULLOUT



- Airy, Breezy, Breathable Extension
- Keeps your linens well ventilated
- Perfect stand-in for a laundry extension

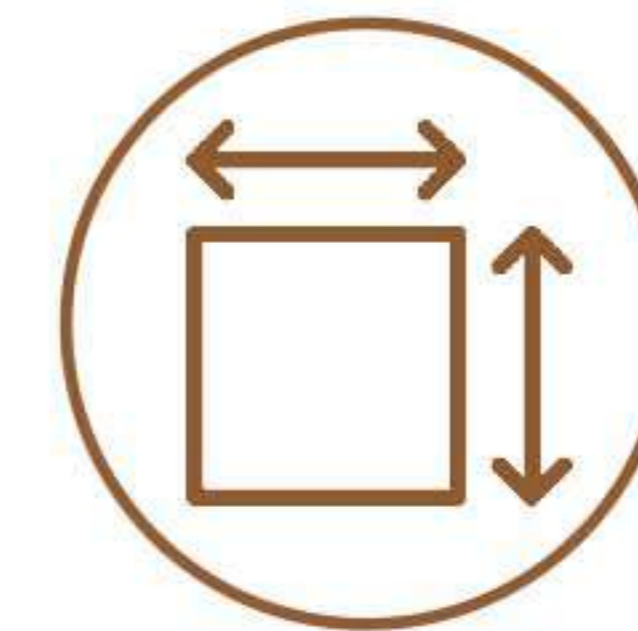

W X D X H
564 x 469 x 184
864 x 469 x 184

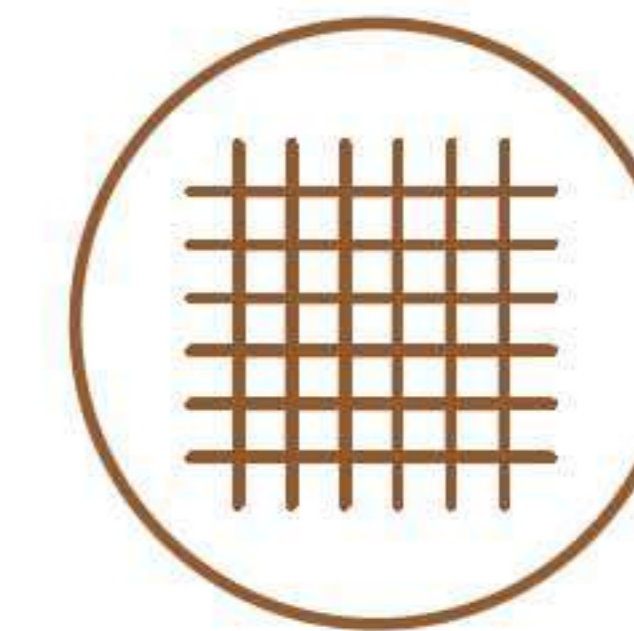

Mesh



Apparel
Storage

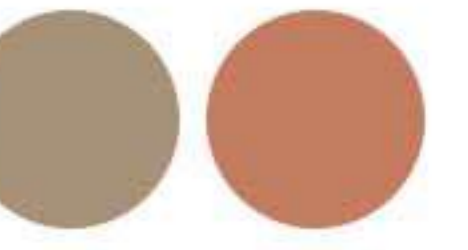
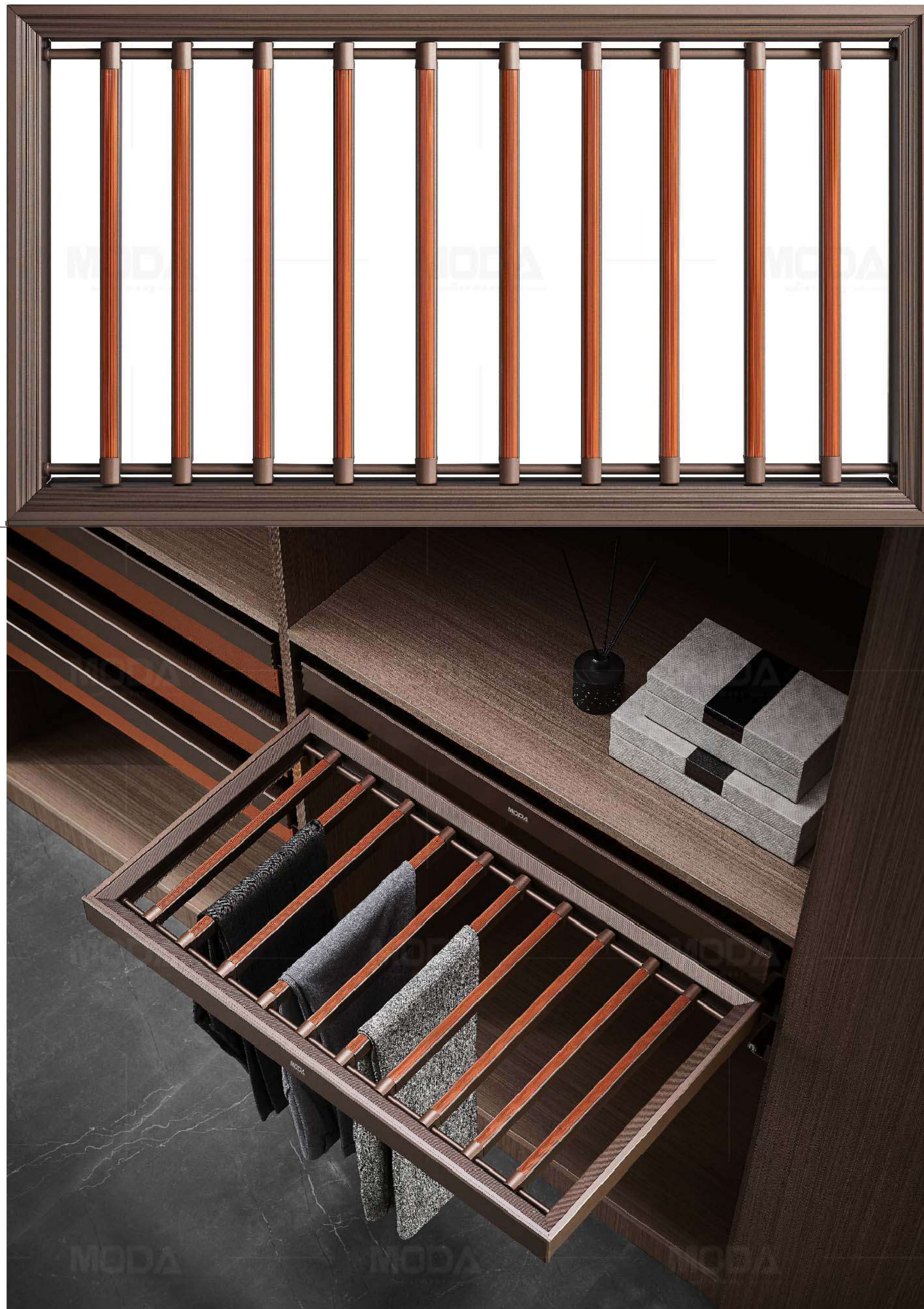

TROUSER PULLOUT

- Chic, Organized Trouser Sorter
- Doubles-up as a Saree Holder
- Perfect accompaniment to Ironed Linens

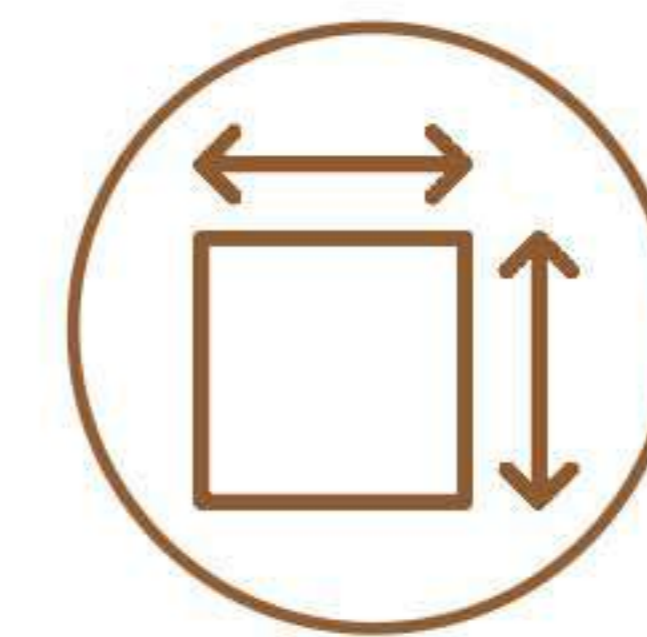

W X D X H
564 x 469 x 65
864 x 469 x 65

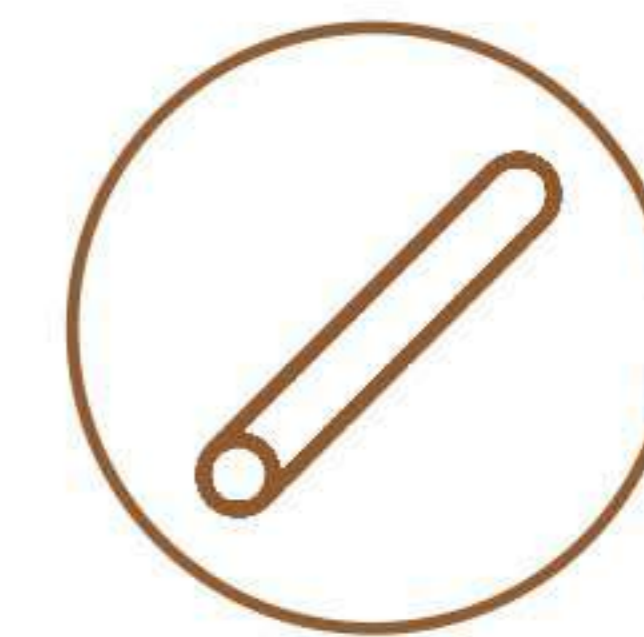

Trouser
rods



Trouser/
Saree

TOP HUNG HANGER

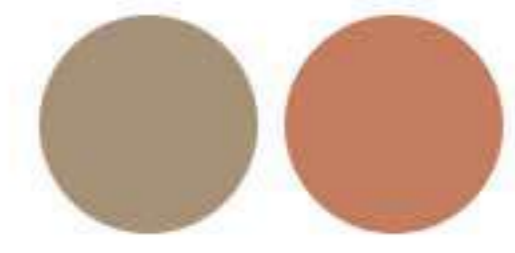

- Space Saving & Easy Extender Accessory
- Snugly fits in compact spaces
- Perfect for sorting out weekday work-wear

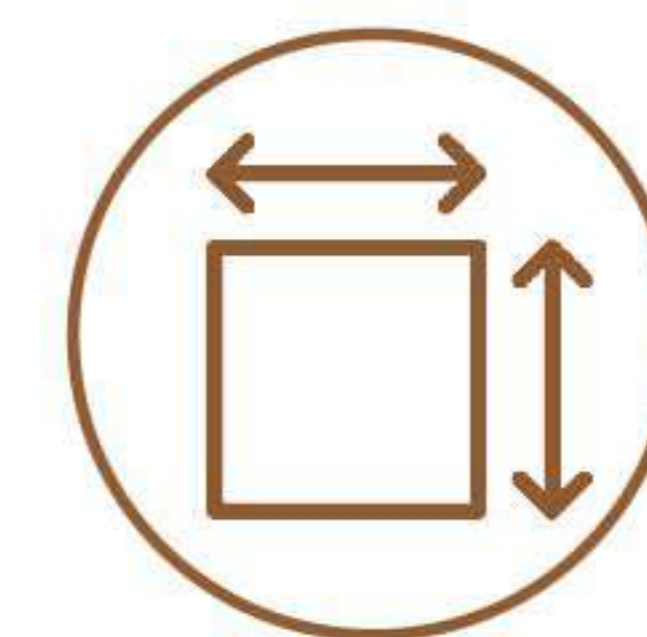

W X D X H
340 X 455 X 140



Vegan



Application

TOP HUNG TROUSER RACK

- Space Saving & Easy Extender Accessory
- Snugly fits in compact spaces
- Perfect for sorting out weekday trouser

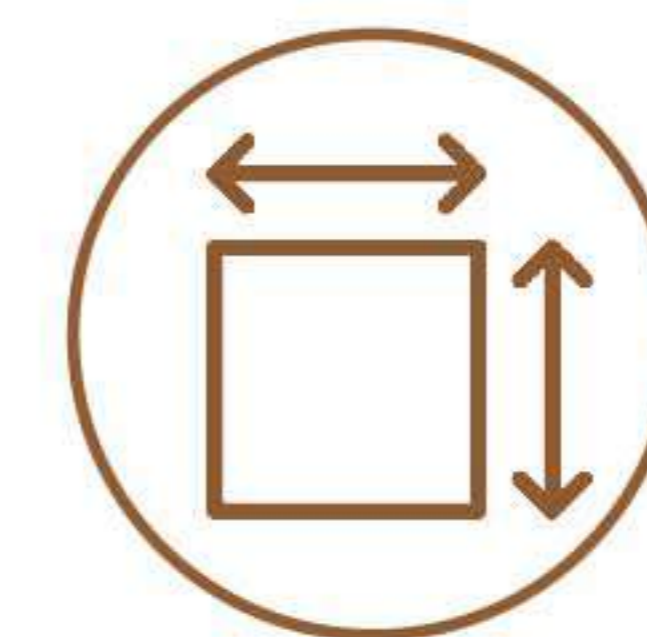

W X D X H
340 X 455 X 140



Vegan



Hanger
storage

SWIVEL MIRROR PULLOUT



- Smart, Easy Tuckaway Mirror Extension
- Snugly fits in compact spaces
- Perfect for the last-minute fit-check!

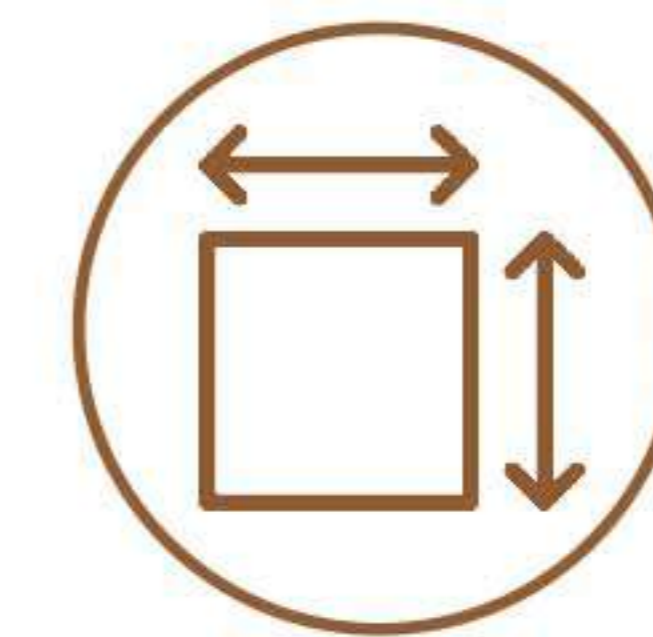

H X D
1200 x 350

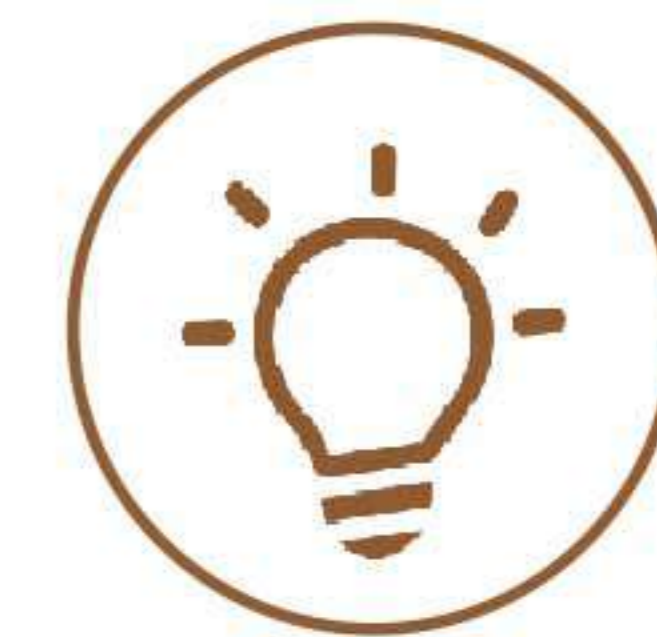

Vegan



Hideaway
Vanity

SHOE RACK SWIVEL



- Plush Revolving Shoe Rack
- Affords a 360degree turn-around storage
- Perfect for all

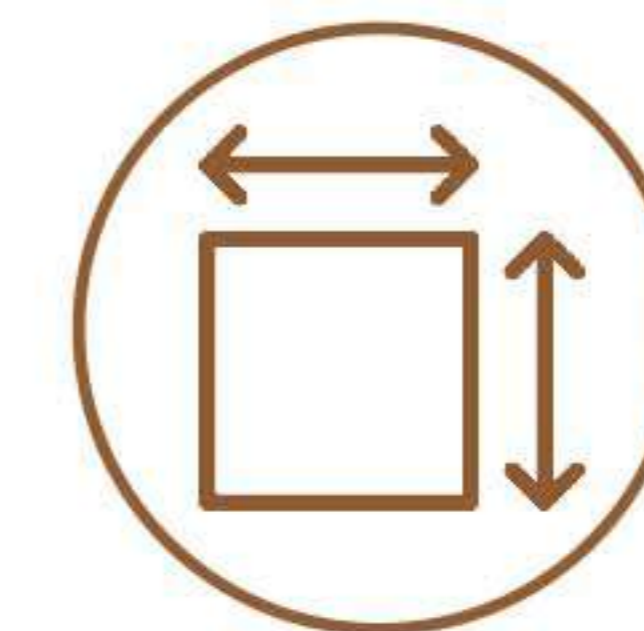

W X D X H
700×360× 1070-1270
(6 layers)
700×360× 1910-2110
(12 layers)



360
rotating icon



Footwear
storage

HANGER PULLDOWN



Hanger pull down
W X D
3/2.4 M X 30 MM

CONERO SERIES

by Kesseböhmer



The extensive range for dressing rooms Assemble your perfect outfit in just a few movements of the hand; CONERO from Kesseböhmer now offers a range of fittings for these rooms, with customisable functional elements to create a design-focused ambience for all your favourite clothes. From wardrobe lift and tie organiser to ring tray, CONERO covers all your needs.



● ● CONERO
INSERT TRAYS



powder black



powder gold

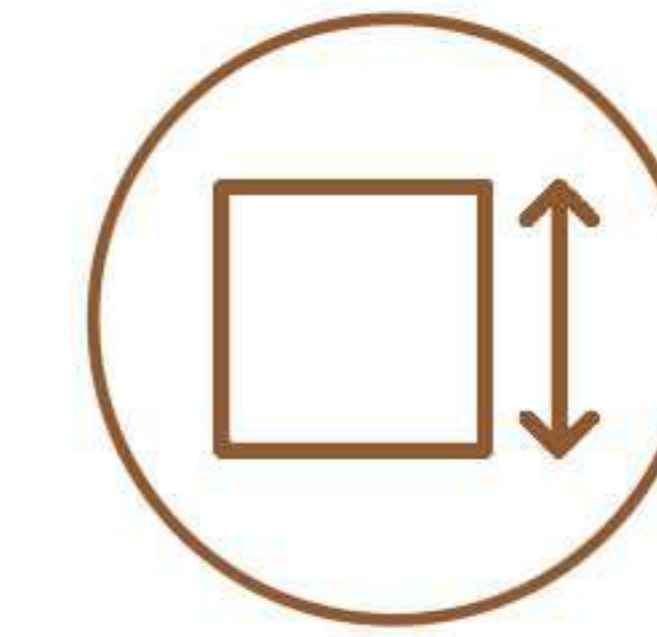

Height
72mm

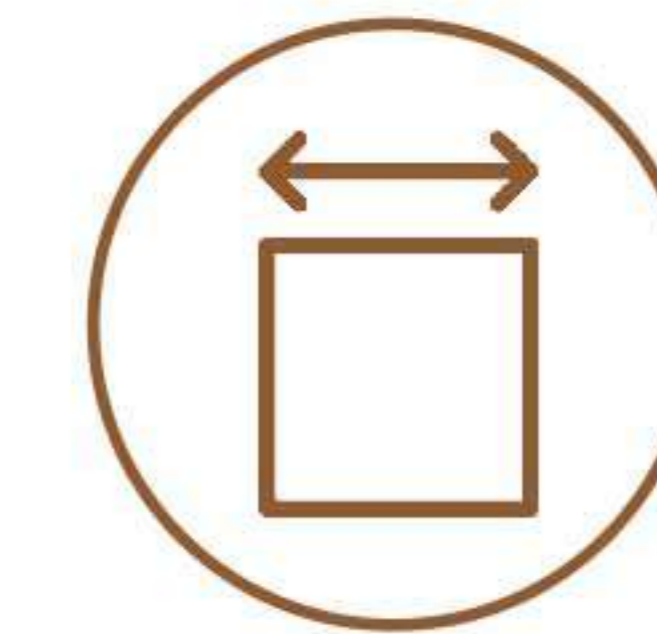

Widths
600, 650, 700, 750
800, 850, 900
950, 1000mm

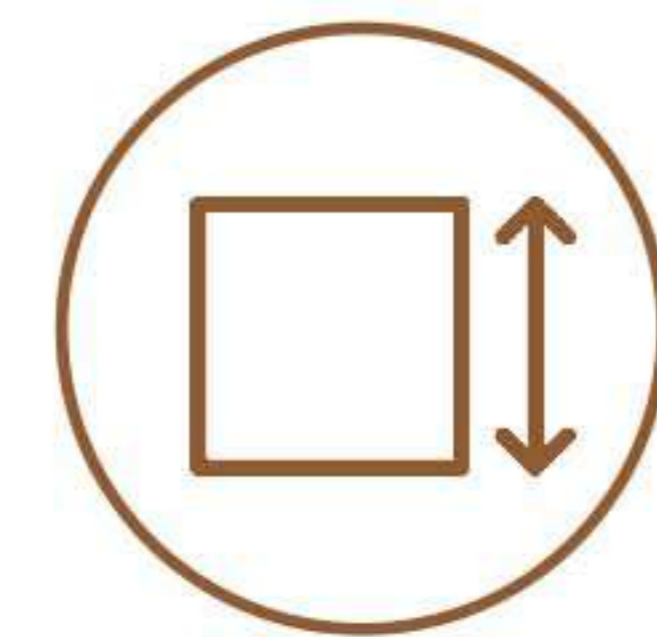

Height
168mm

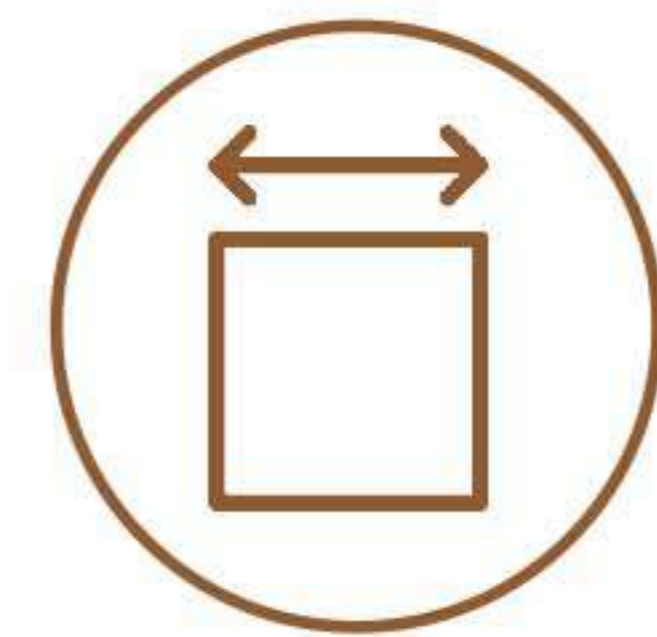

Widths
600, 650, 700, 750
800, 850, 900
950, 1000mm

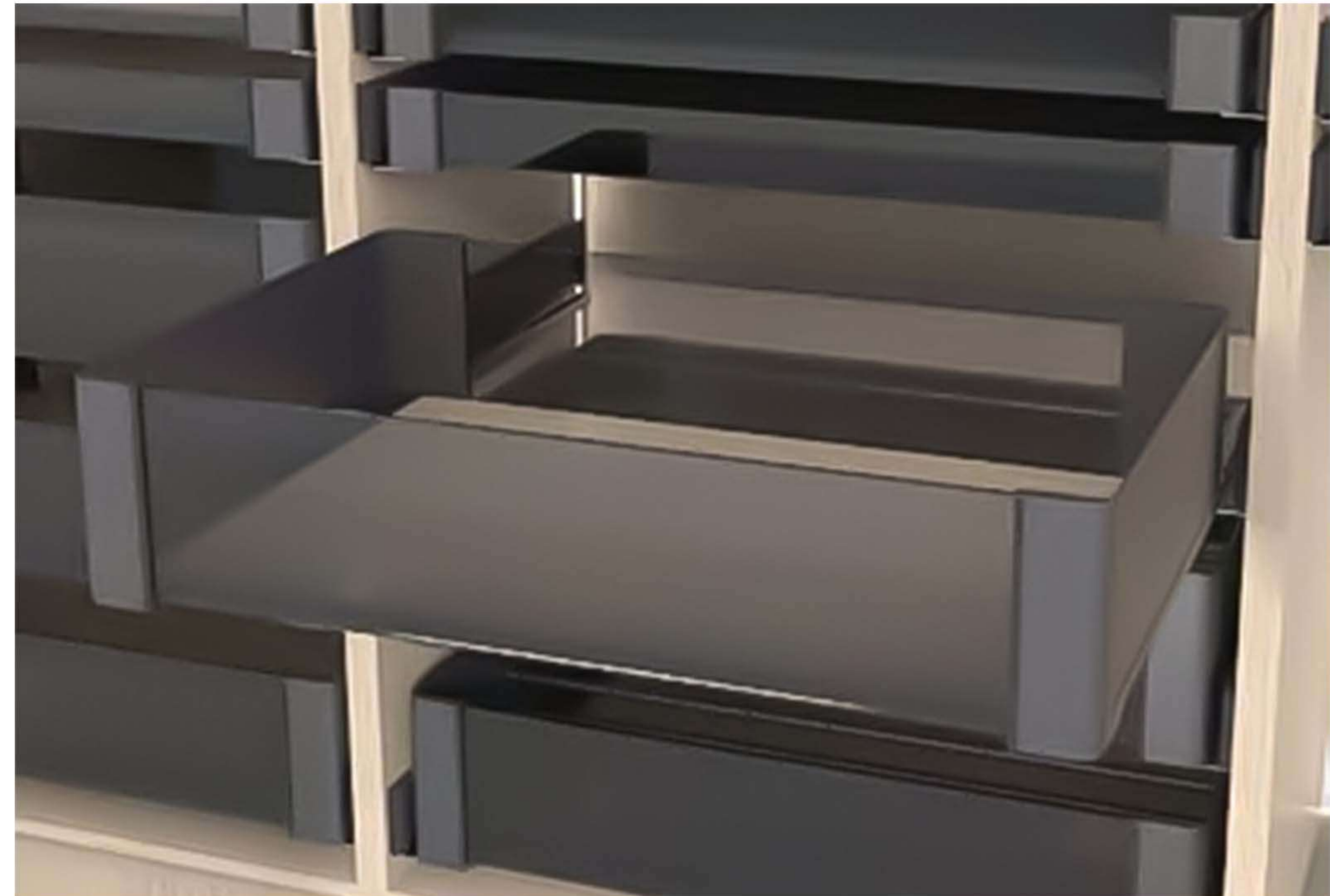



●● IRON PULLOUT



Aesthetically designed space saving ironing board which slides in the wardrobe easily. Easy to use in standing position on the board can be easily rotated 180 degree for left and right hand side positions.

Wardrobe pullout ironing board
W X D X H
430 X 300 X 140

●● CONERO FLOCK INSERTS

Conero's Velvet Flock Inserts afford plush comfort and gentle storage for delicate accoutrements and Fine-wear, protecting and showcasing, all the same...

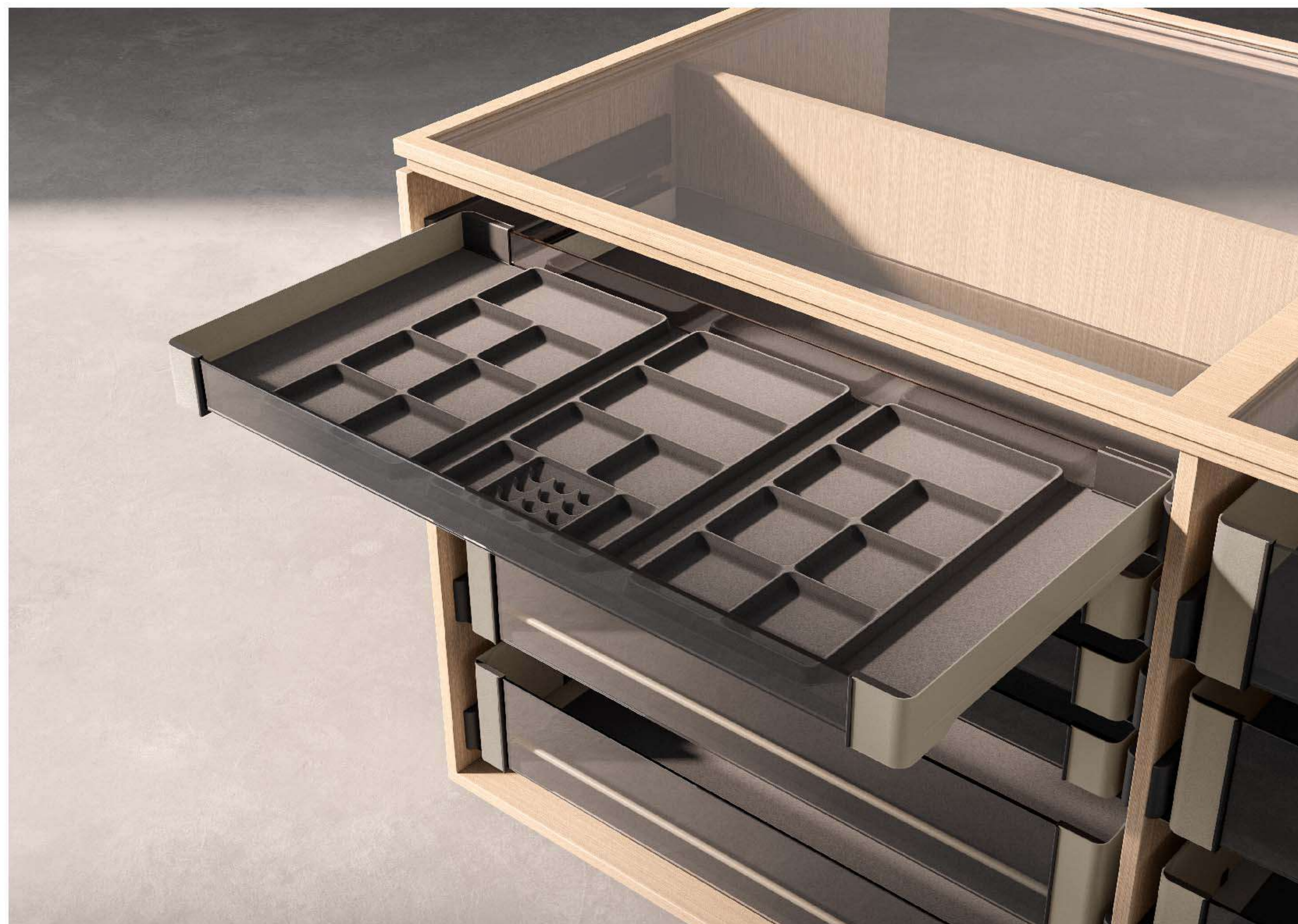
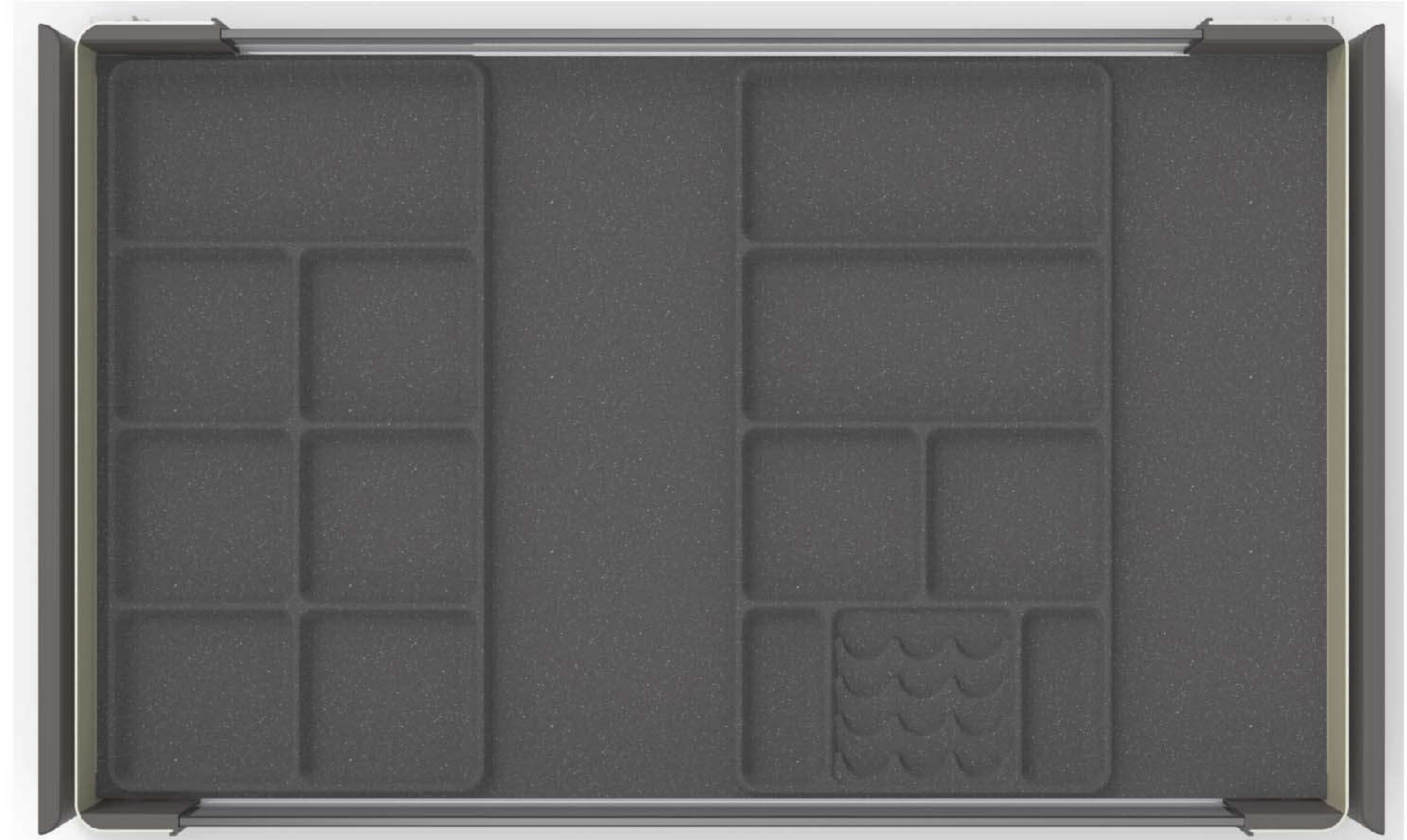

Conero Interior flock
W X D X H
715 X 425 X 20
1020 X 425 X 20

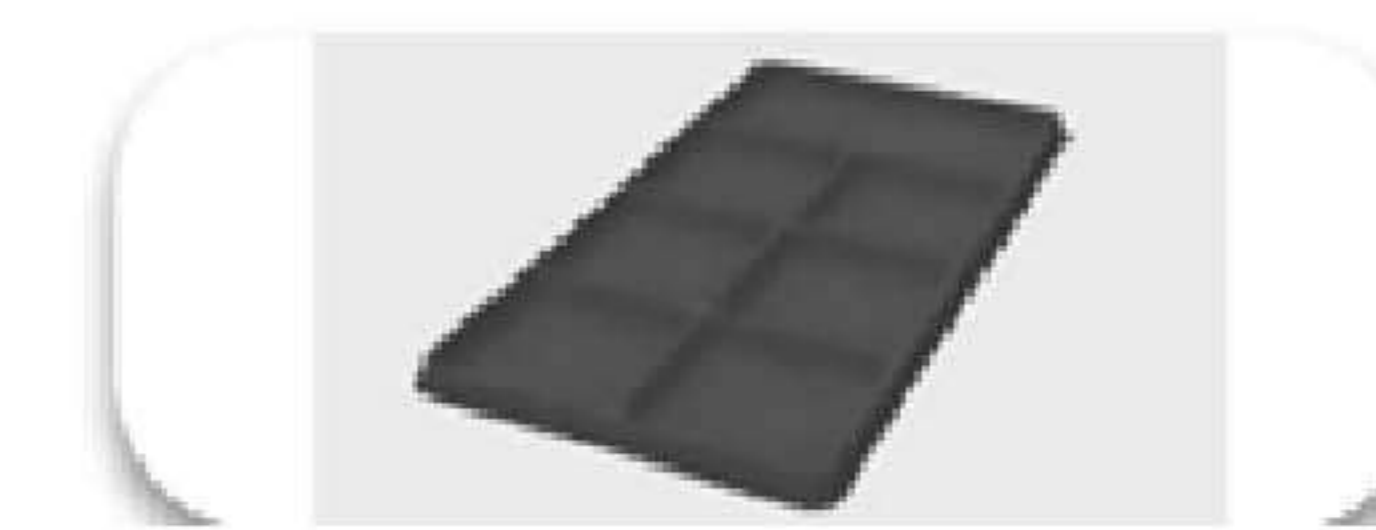

Conero Jewellery & ring bowl
W X D X H
223 X 425 X 14

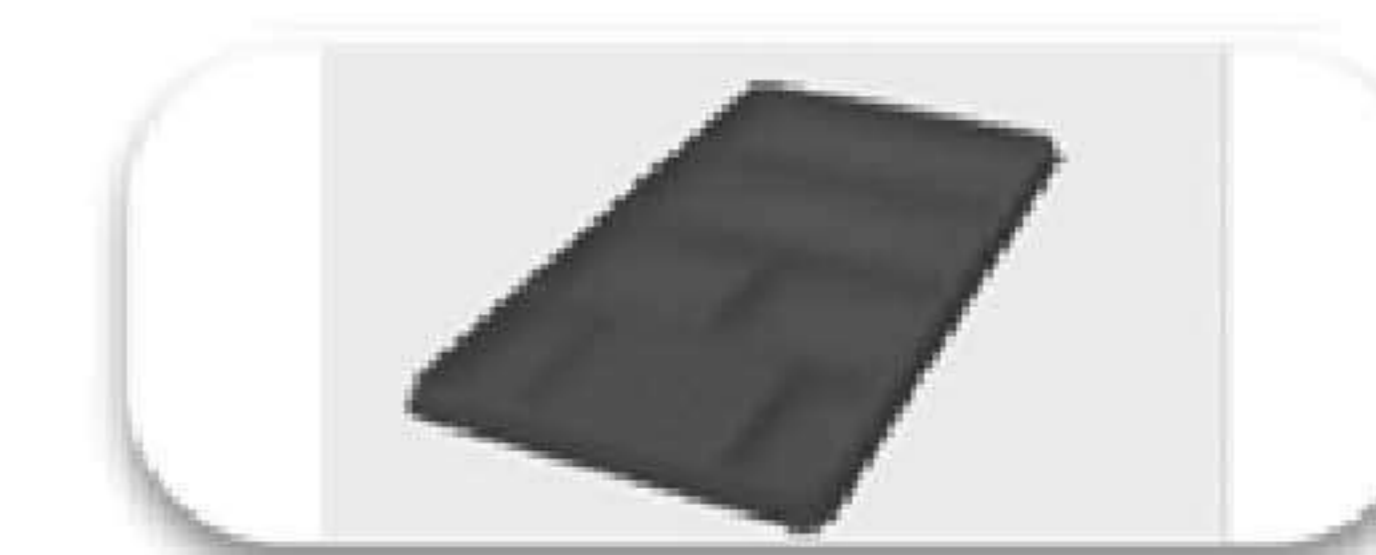

Conero belt & tie bowl
W X D X H
223 X 425 X 14



WARDROBE LIFT

Kessebohmer's Top Lift combines ergonomics that address stubborn closet spaces, for the first time, globally. A pulldown with an inbuilt shelf provision like no other...

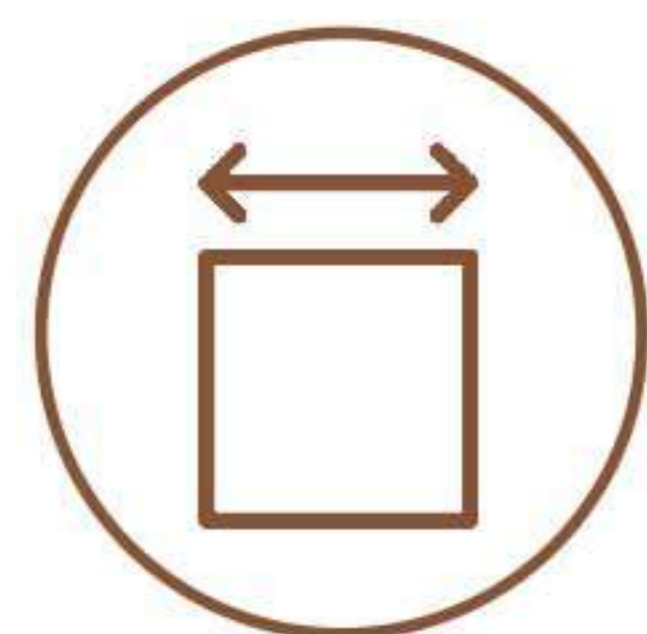

Width
450mm- 1200mm



12-15 kgs



●● HANGER RODS

Conero's Hanger Systems combine linearity with Enduring sophistication. Inbuilt is a silencer gasket that aids you to slide your hangers across smoothly. Designed to define, Hold and Elevate your closet.

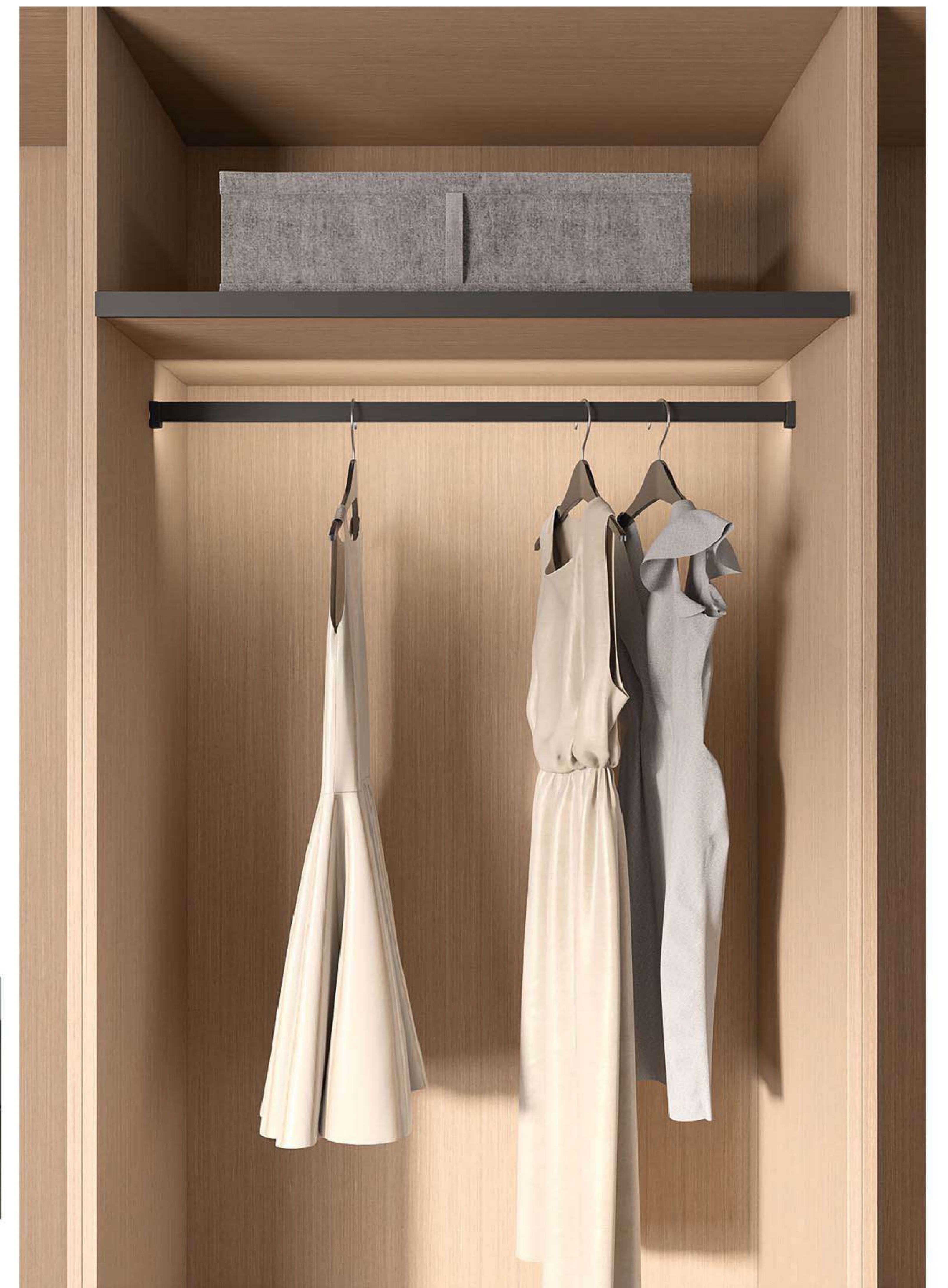

CONERO clothes rail
L X P X H
919 X 15 X 30
1219 X 15 X 30



powder black



powder gold

●● LAUNDRY



Conero Laundry bag, Narrow

W X D X H

190 X 280 X 530

Conero Laundry bag, Wide

W X D X H

300 X 280 X 530



Conero Shoe fence
W X D X H
582 X 24 X 38
1114 X 24 X 38



SHOE PROFILE

Incline and Stun with these simple shoe rack profiles from Conero that help you rack up without losing a smidge of glamour...



●● CONERO TROUSER PULLOUT

Preparing for a workday never got easier; Conero Trousers Rack helps you keep track of your Work-day staples while helping you keep your finery Crease-free!

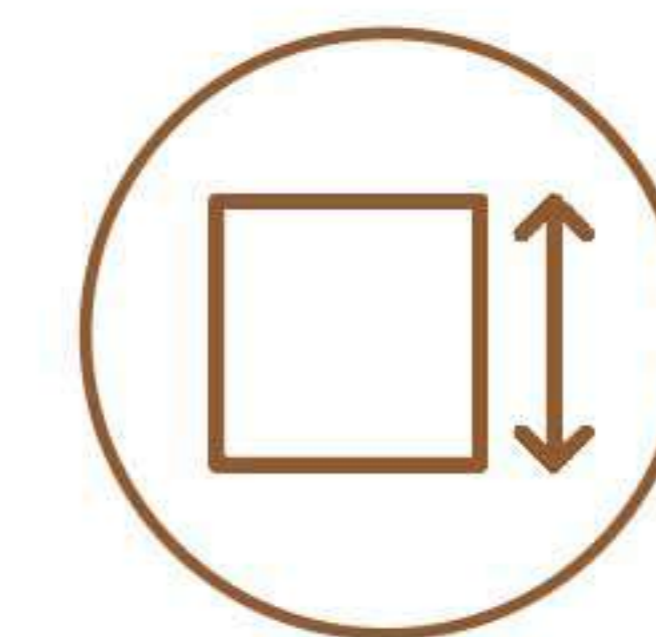

Height
72mm

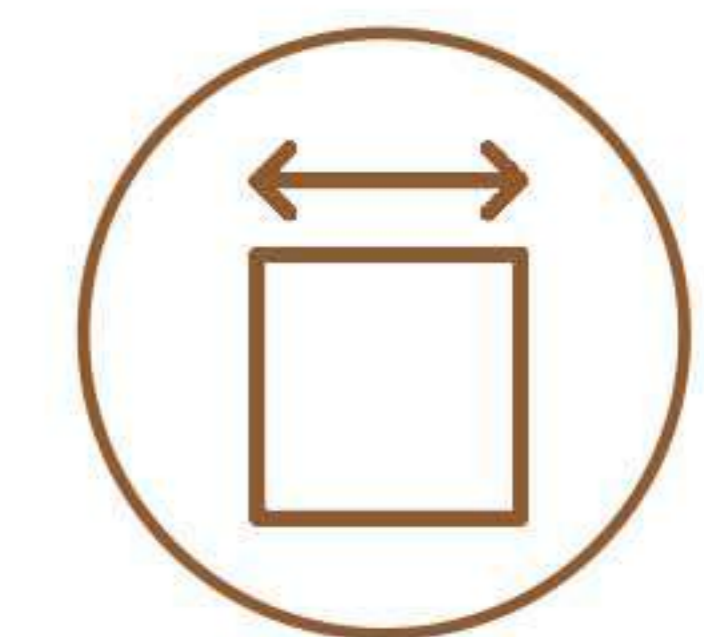

Widths
552-612, 710-770
760-820, 810-870
860-920, 910-970,
960-1020

MIO

by Kessebohmer

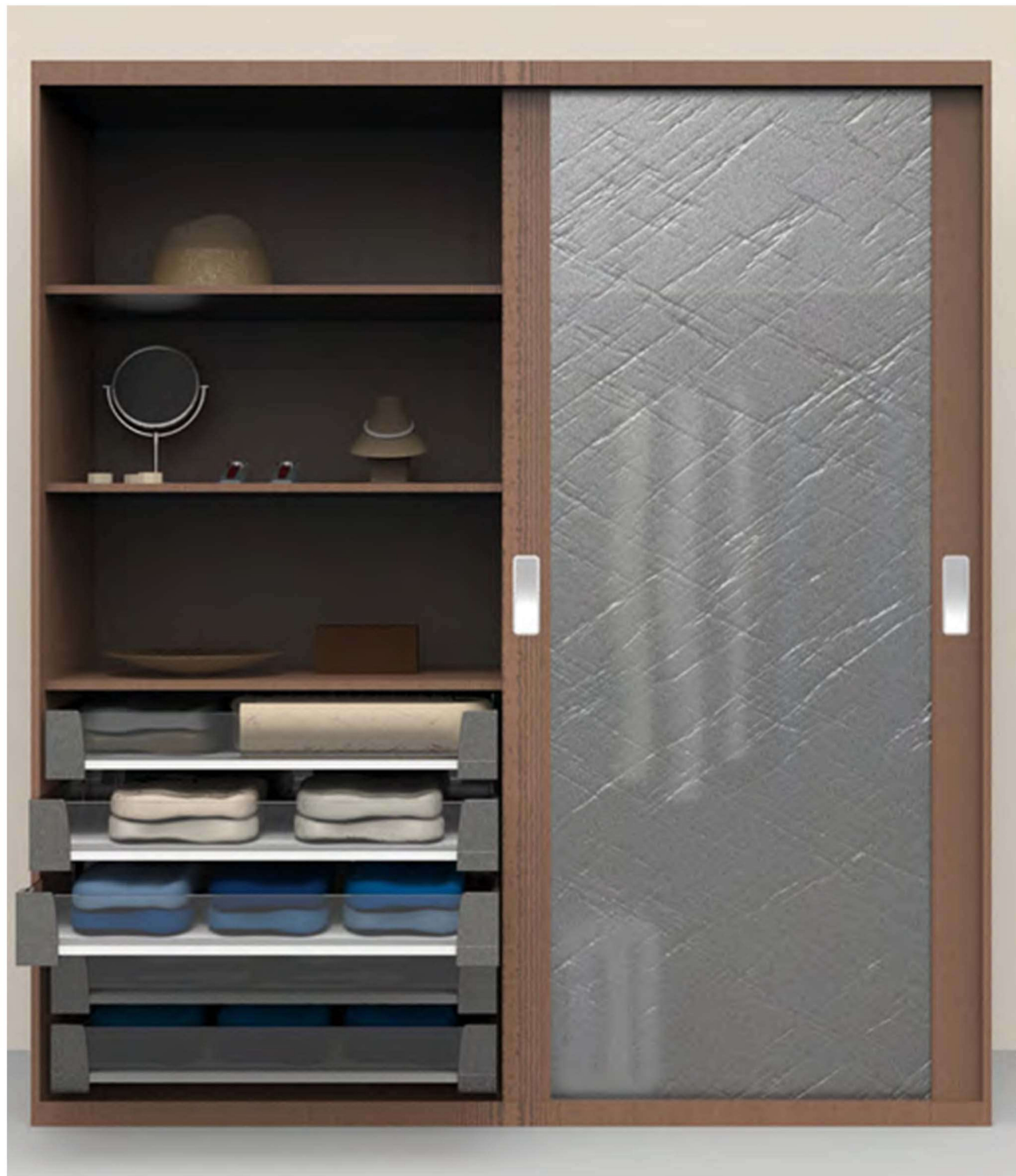

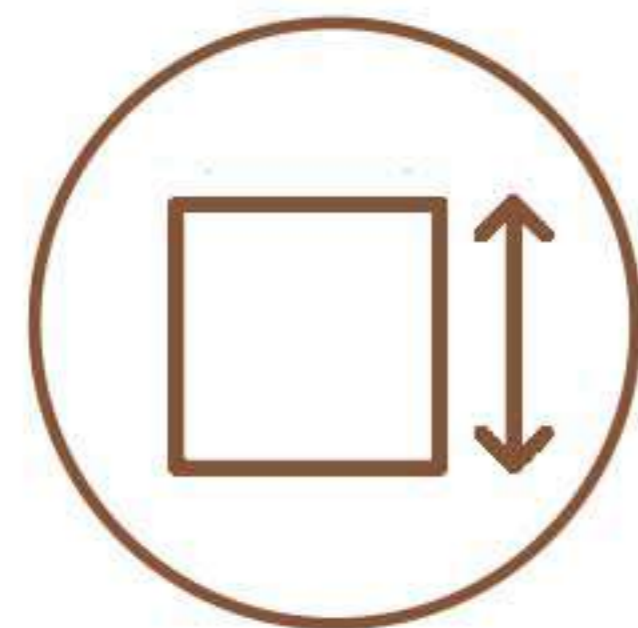

Height
98mm, 129mm, 167mm



Widths
600, 650, 700, 750
800, 850, 900
950, 1000mm

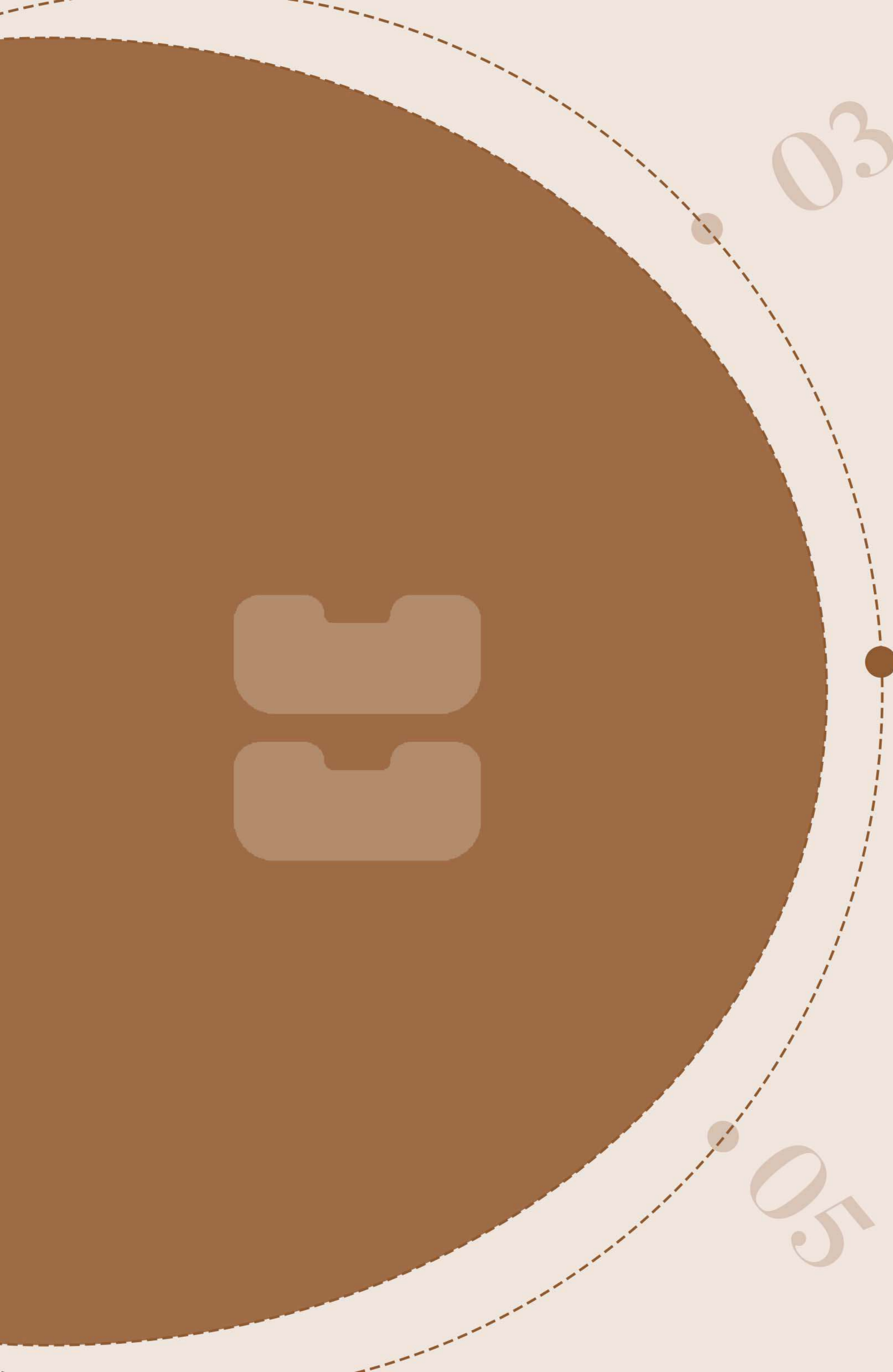

● 04 Wardrobe
Organiser
Inserts





An **organized closet** is undeniably the way to an organized lifestyle. And to achieve that, you need accessories that can help you look beyond the clutter of everyday.

Our Vegan leather pullout organizers not only imbue style and sophistication, But open up the possibility of a **dynamic wardrobe space** that lends itself to your evolving demands as you get ready to conquer the day.

MAKEUP ORGANISER

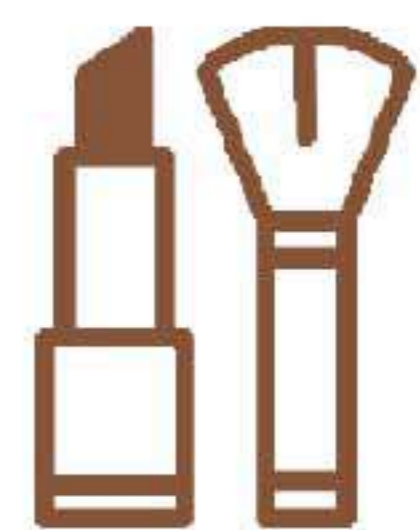

W X D X H
165 X 425 X 50 MM

MULTIPURPOSE ORGANISER

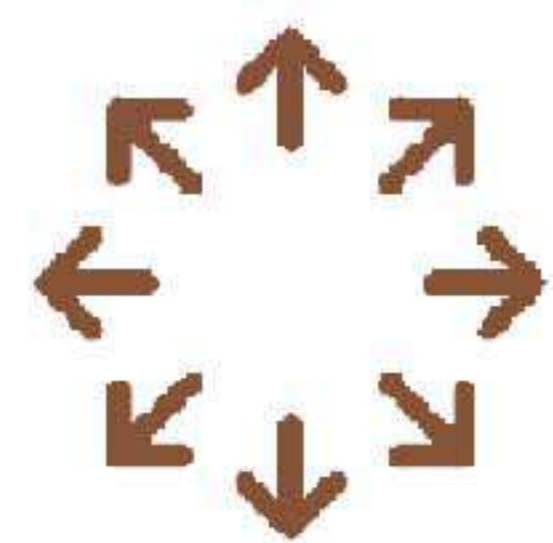
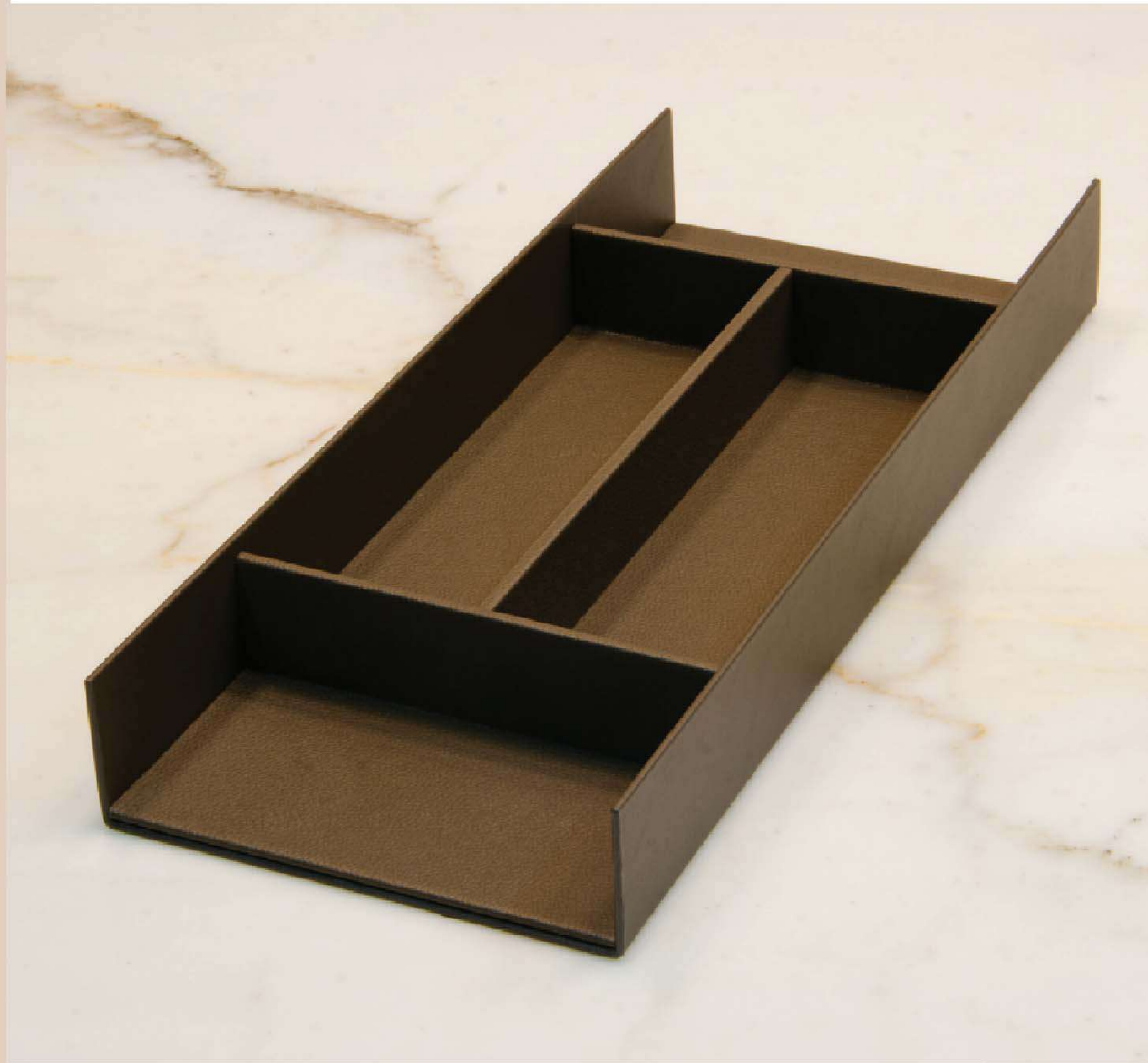

W X D X H
165 X 425 X 50 MM

WATCH ORGANISER

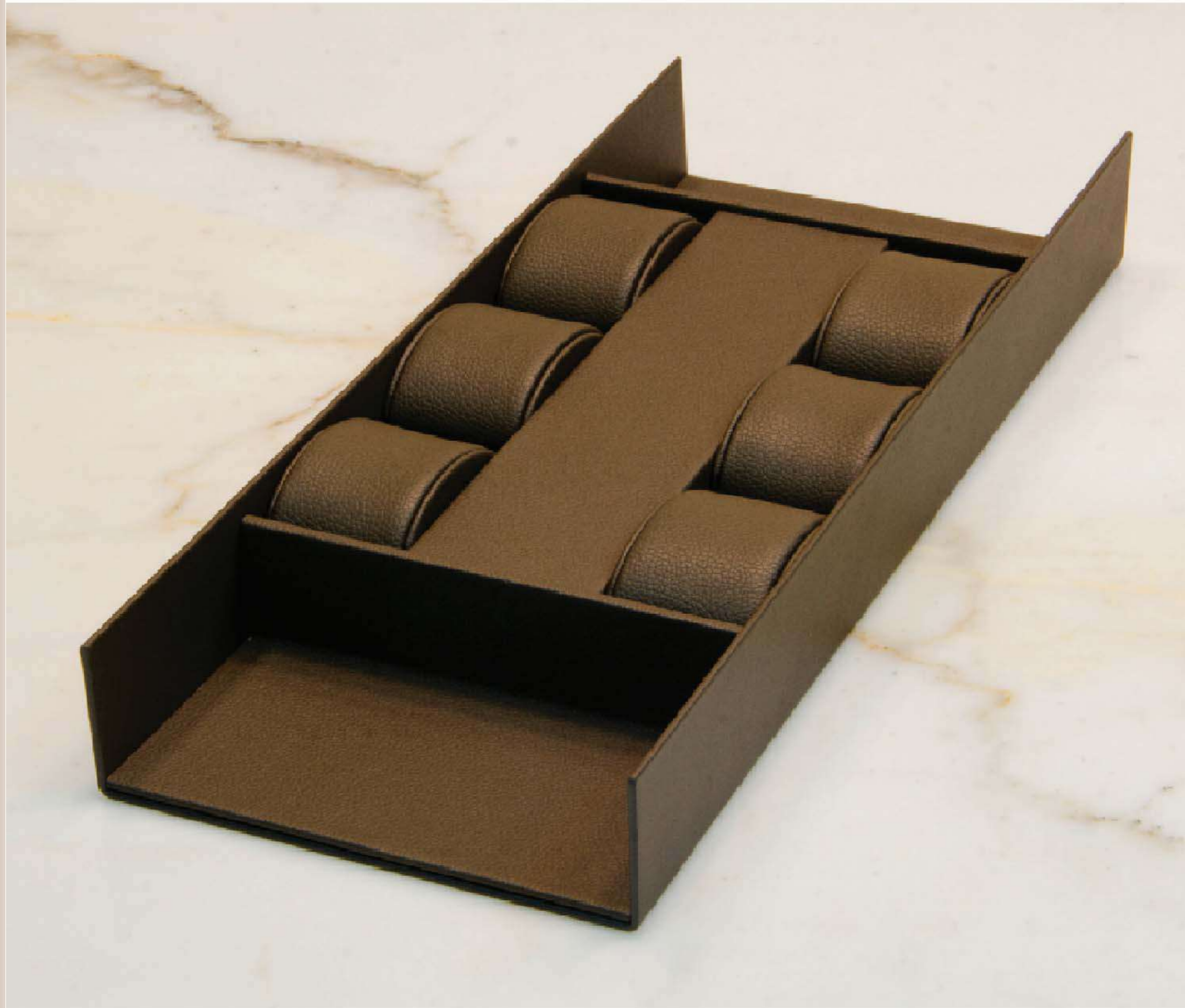

W X D X H
165 X 425 X 50 MM

RING ORGANISER



W X D X H
165 X 425 X 50 MM

EYEGLASS ORGANISER



W X D X H
165 X 425 X 50 MM

04



● 05 Wardrobe
Lighting
Profiles



06



RECESSED SUPER SLIM
H 9.3 mm X D 6.7 mm
Profile length : 3000mm

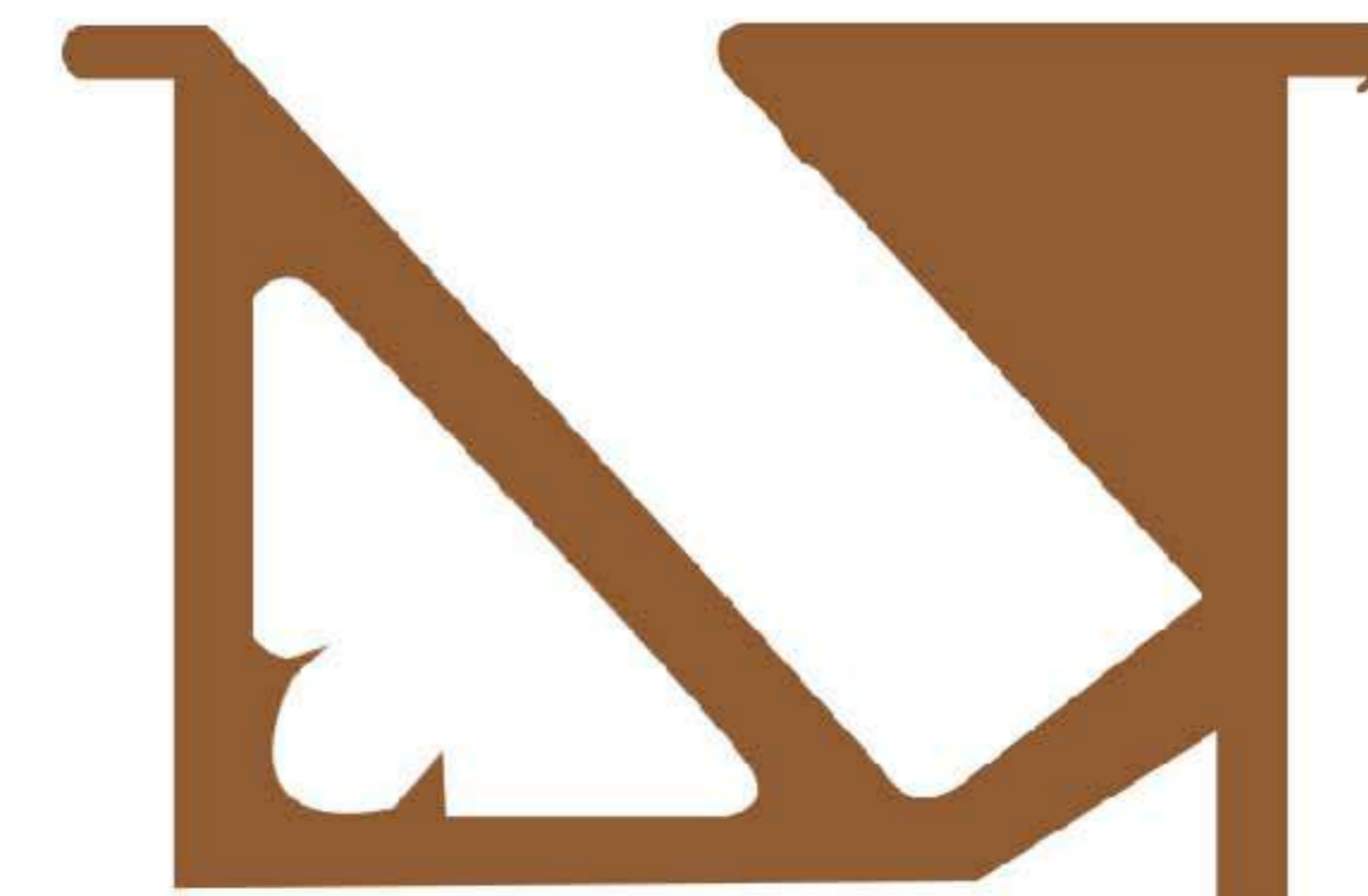

RECESSED ANGULAR SLIM
H 9.5 mm X D 16.5 mm
Profile length : 3000mm

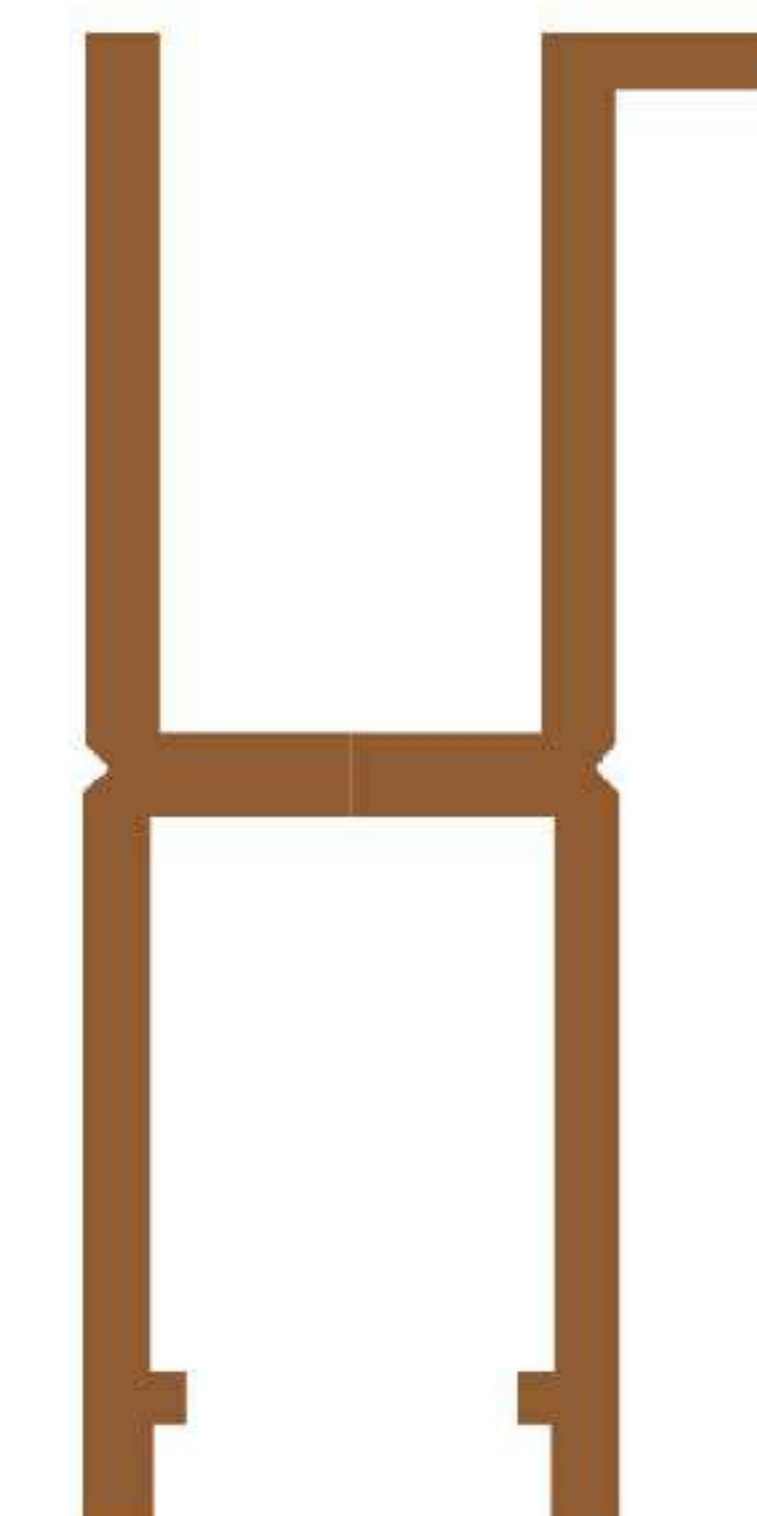
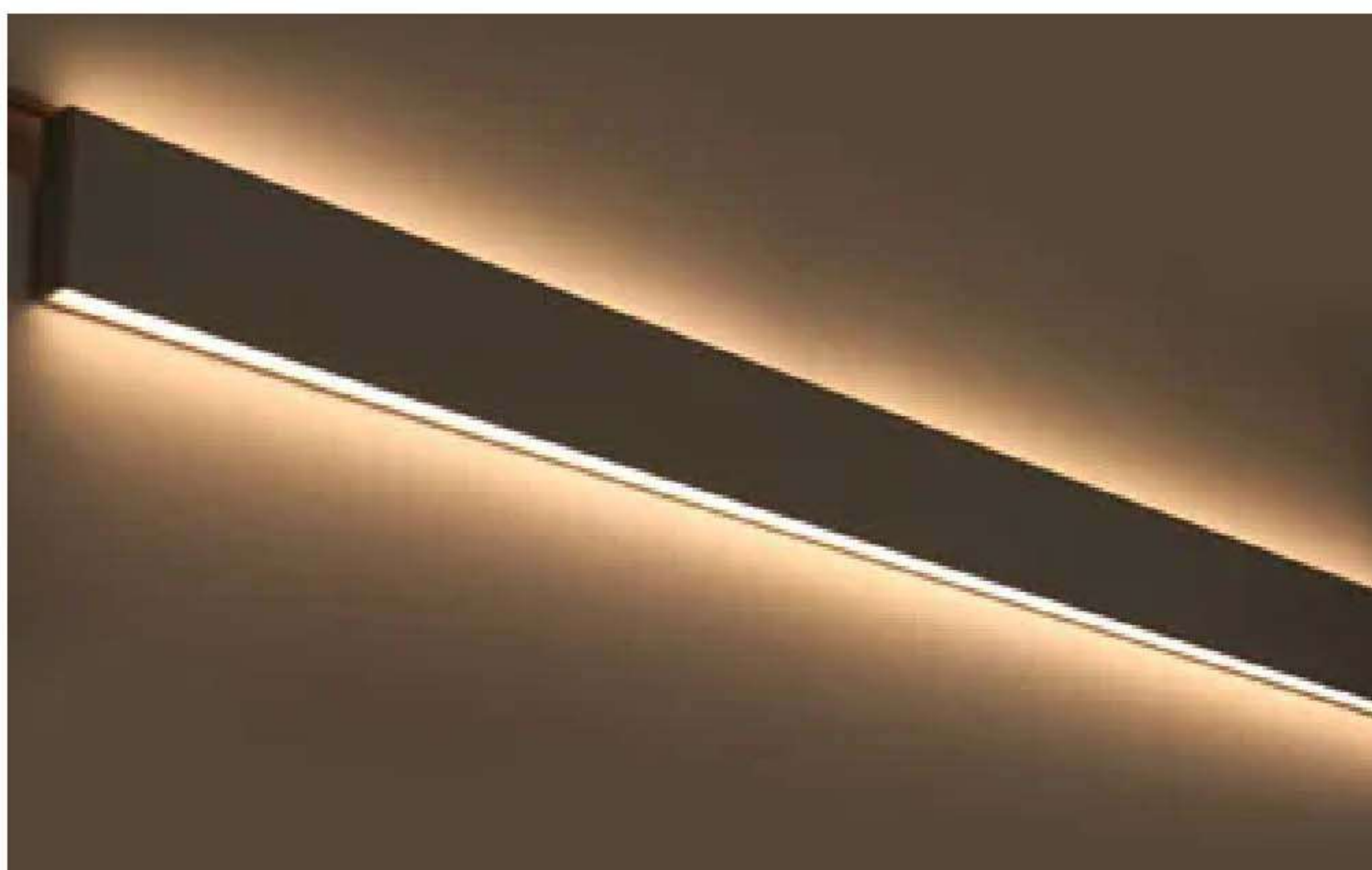

UP DOWN BLACK
H 16.9 mm X D 8.4 mm
Profile length : 3000mm

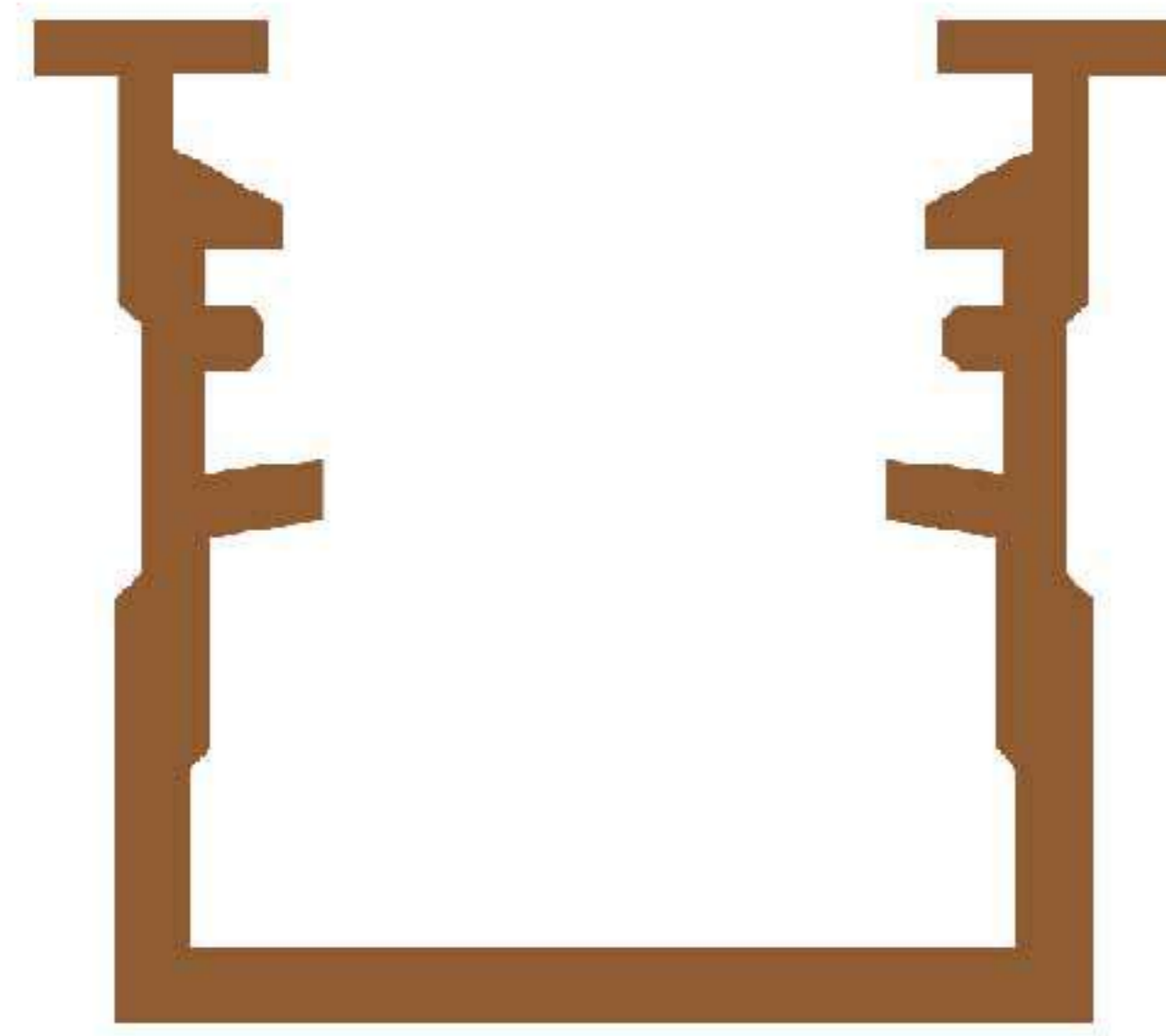

RECESSED SLIM
H 10.2 mm X D 11.4 mm
Profile length : 3000mm

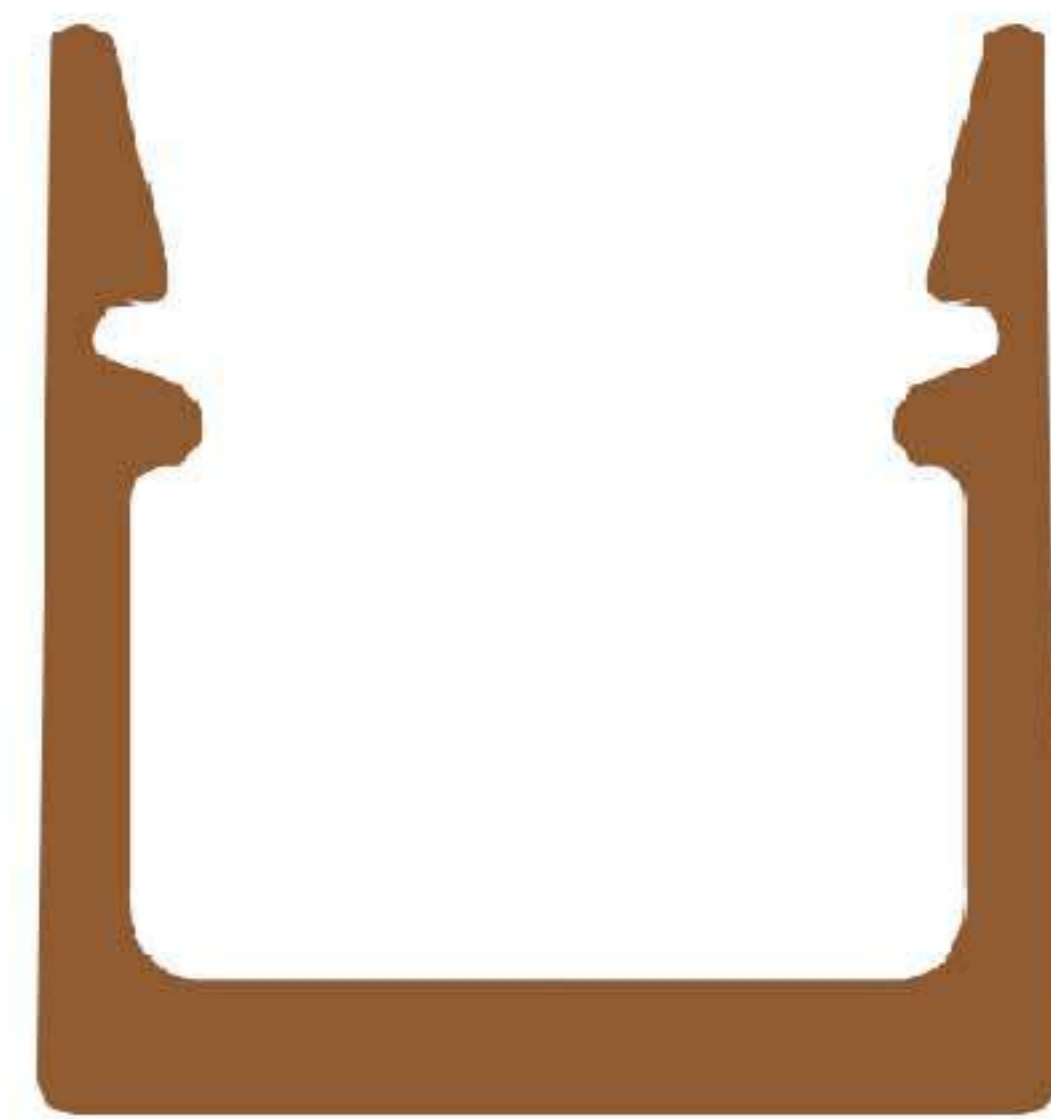

SURFACE MOUNTED SLIM
H 10 mm X D 10 mm
Profile length : 3000mm

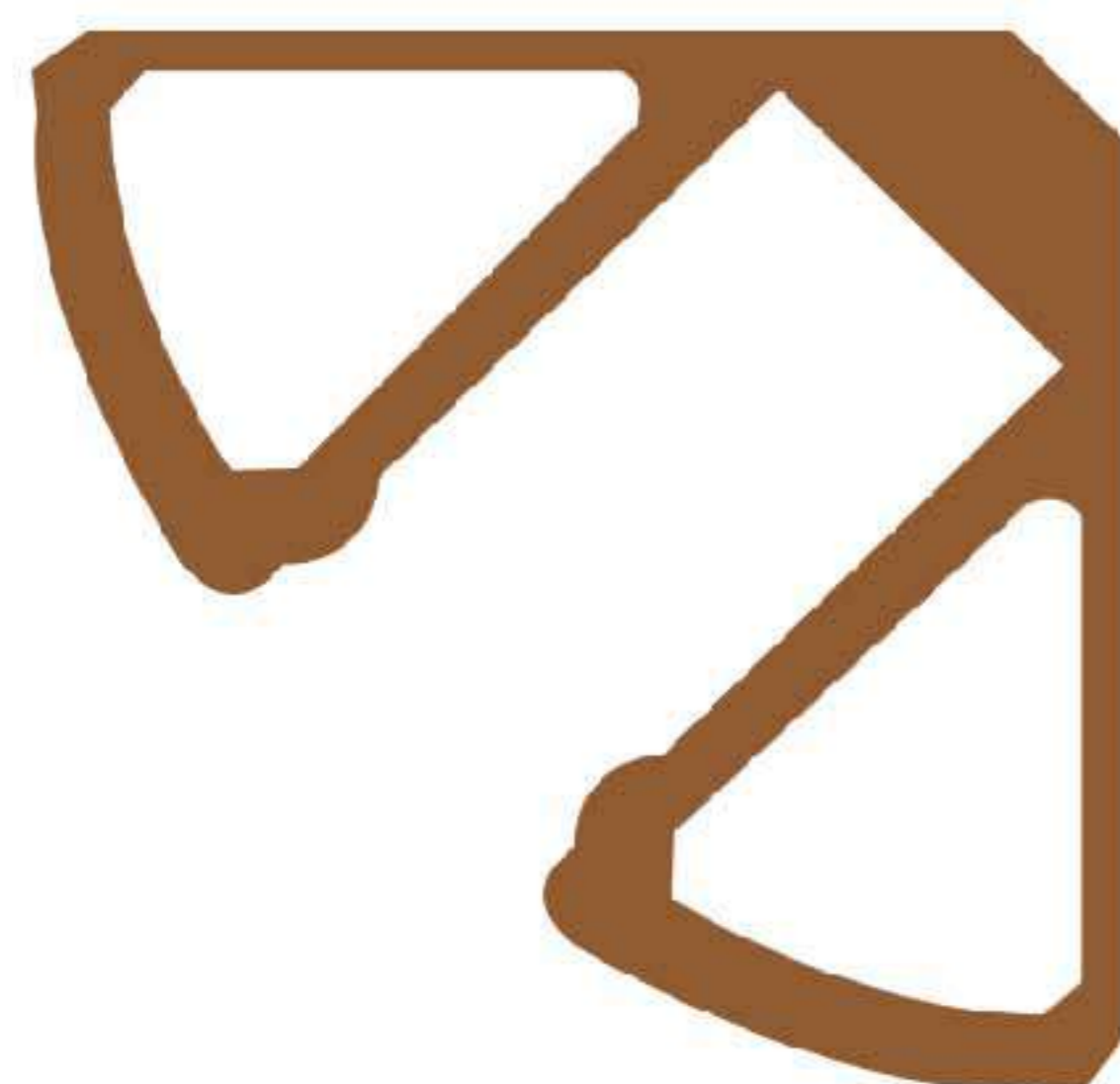

CORNER ANGULAR
H 12 mm X D 12 mm
Profile length : 3000mm



05

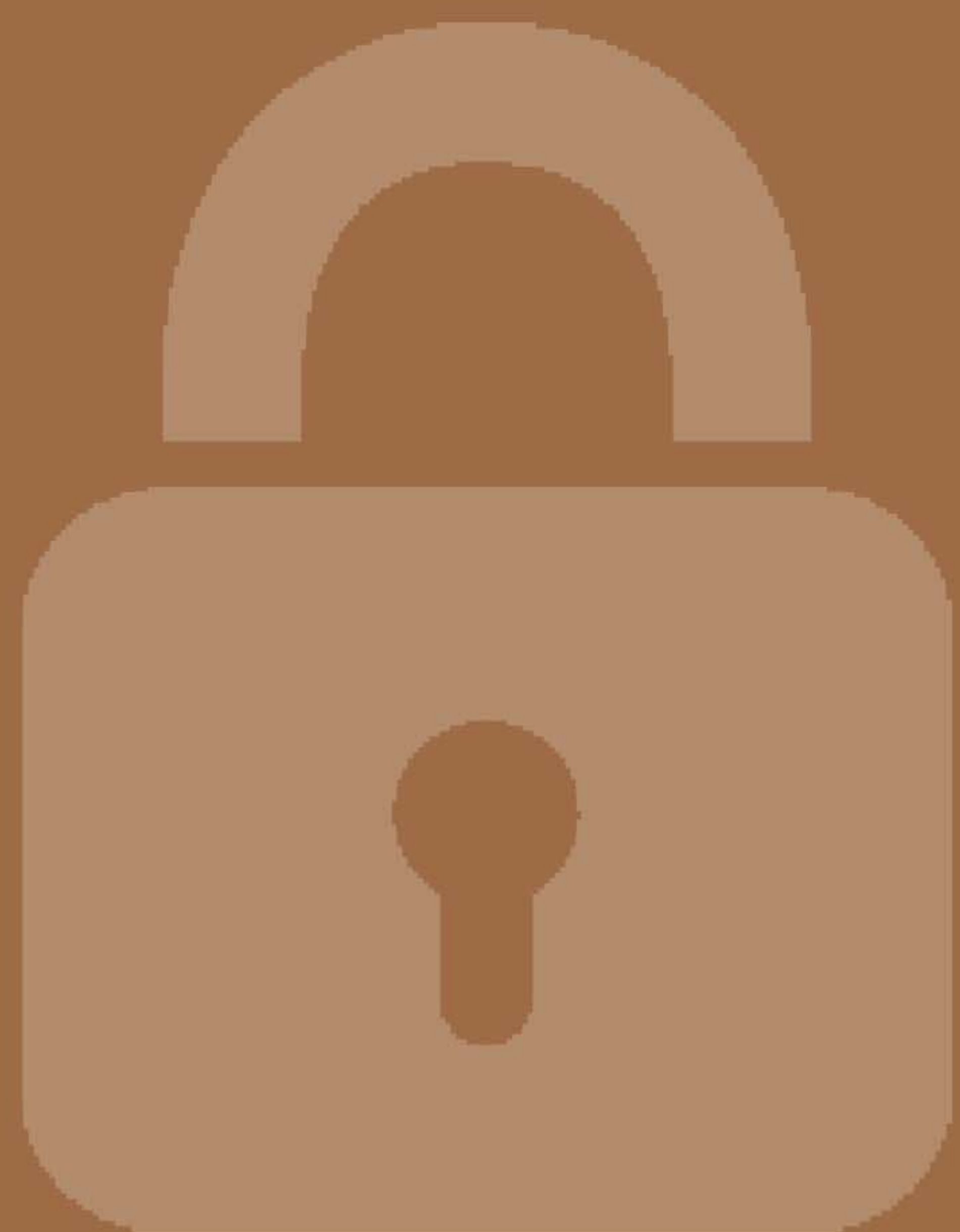

● 06 Wardrobe
Locking
System



07

BIOMETRIC SMART PREMIUM FURNITURE LOCK



- Upto 10 Different Users
- Micro USB port for emergency opening
- Automatic Opening & Closing
- LED Light & Sound indicator for opening
- Lock for furniture drawers, cupboards and Wardrobes

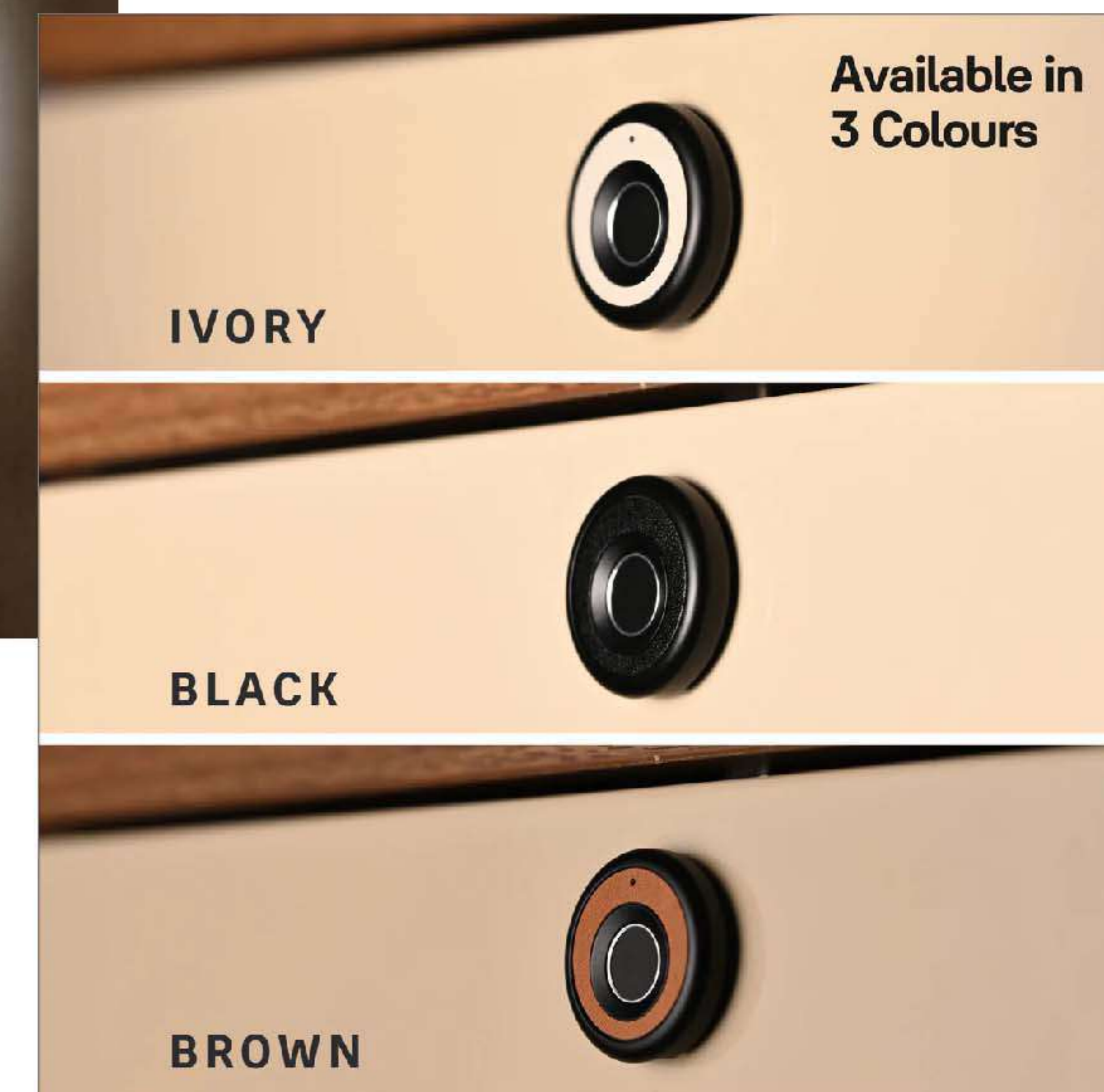

**Power Bank Support
in case of Emergency**



Low Battery Warning 
Use 3 x AAA Alkaline Battery

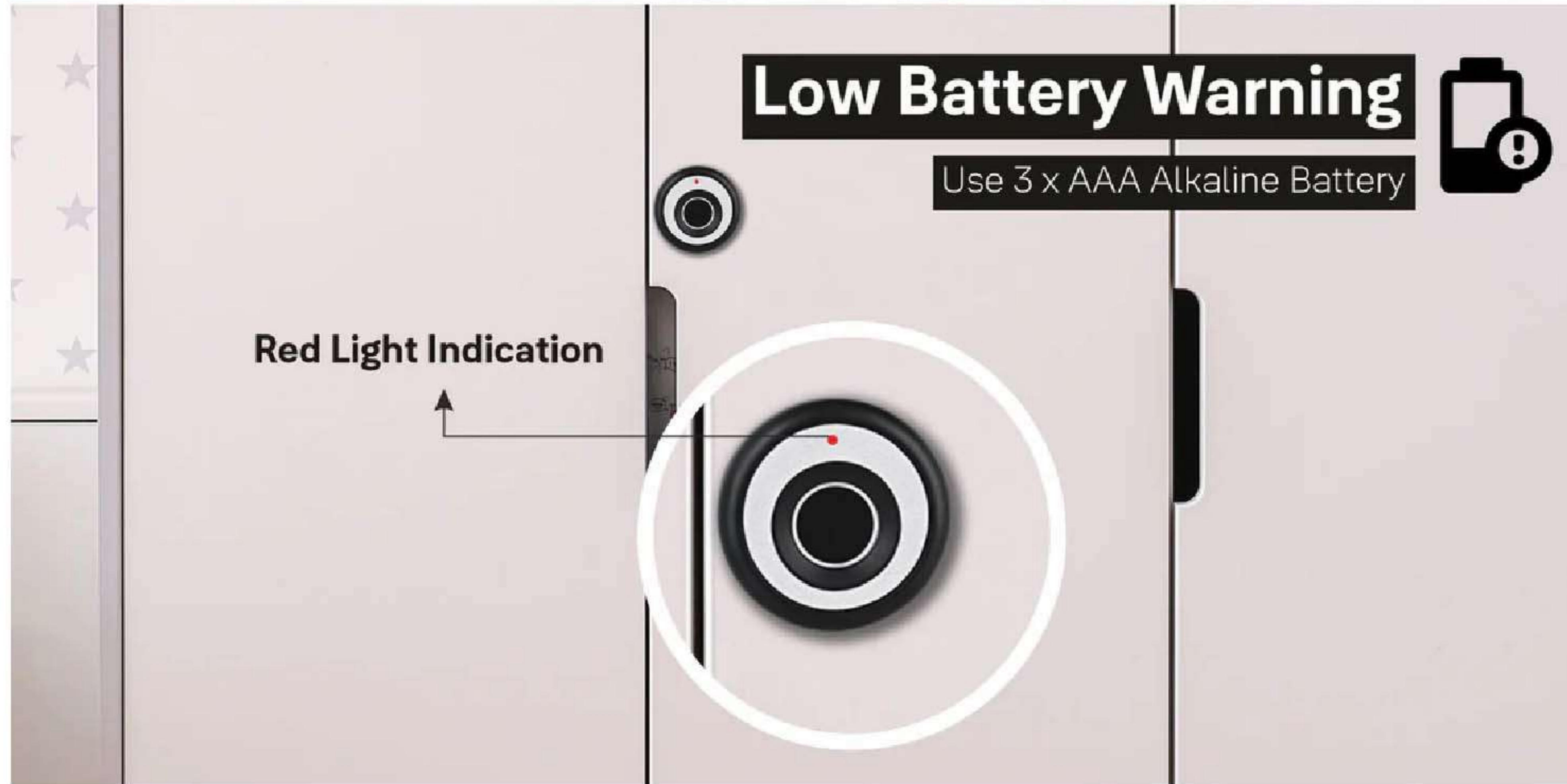

**Fingerprints are the
only Keys**



FINGERPRINT WARDROBE LOCK FOR OPENABLE DOOR



- Admin and User fingerprint access
- Emergency Exit button
- USB Port for emergency power supply
- Automatic Locking
- Wrong fingerprint Alarm entries
- Low Battery Indicator



Door thickness
18mm to 30mm

MESH PIN DIGITAL WARDROBE LOCK FOR WARDROBES AND CABINETS



- KeyPad Pin Code operation
- Password : 4- 15 Digits
- Master and Normal User
- Enabled with Code Scrambling
- Strong Zinc Body
- Can be installed on both wooden and metal doors
- Usage – Both Residential and Commercial (Offices/Gyms/Amusement Parks etc)



**Door thickness
Till 21mm**

INVISIBLE REV- A- LOCK



- No lock visible on the outside
- Secret chamber for lockers and valuables
- Magnet catch (pointing to the white thing inside the door)



GJ Enterprises

mail jai@gjenterprises.co.in
call +91 98410 68249
website www.gjenterprises.co.in
Address 153 Raju Nagar, First Cross
 Thoraipakkam, Chennai – 600 097

Follow us on instagram [@gj_designerhardware](https://www.instagram.com/gj_designerhardware)